

MOVING YOU FURTHER

# HX145LCR

With Tier 4 final / Stage IV Engine installed



\*Photo may include optional equipment.

**Net Power**

SAE J1349 / 87 kW (116 HP) at 1,950 rpm

**Gross Power**

SAE J1995 / 92.7 kW (124 HP) at 1,950 rpm

**Travel Speed**

5.5 km/hr (3.4 mph) / 3.3 km/hr (2.1 mph)

**Operating Weight**

15,160 kg / 33,420 lb





## RULE THE GROUND

The HX Series excavators are products of HHI's spirit of initiative, creativity and strong drive. HHI's engineers, who are the best in the industry, have worked tirelessly to offer a zero-defect product. The new HX Series reflects customers' needs in the field gleaned by thorough monitoring. They maximize fuel efficiency and performance proven by rigorous field tests and quality control.



\*Photo may include optional equipment.



# RULE THE GROUND

The HX series exceeds customers' expectation!  
Become a true leader on the ground with HHI's HX series.

# HX145<sub>LCR</sub>



## WORK MAX, WORTH MAX

- ECO Gauge
- IPC (Intelligent Power Control)
- New Variable Power Control
- Electronic Viscous Fan Clutch
- Attachment Flow Control (Option)
- New Cooling System with Increased Air Flow
- Enlarged Air Inlet with Grill Cover
- Cycle Time Improvement



## MORE RELIABLE, MORE SUSTAINABLE

- Durable Cooling Module
- Reinforced Pin, Bush and Polymer Shim
- Reinforced Durability of Upper and Lower Structure and Attachments
- Hi-grade (High-pressure) Hoses



## INFOTAINMENT FRONTIER

- Intelligent and Wide Cluster
- Wi-Fi Direct with Smart Phone (Miracast)
- Proportional Auxiliary Hydraulic System
- New Audio System
- New Air Conditioning System



## MODERN COMFORT, SIMPLE AND SAFE SOLUTION

- Easy Access to DEF/AdBlue® Supply System
- Hi MATE (Remote Management System) (Option)
- Viscous Suspension Mount
- Swing Lock System (Option)
- Fine Swing Control (Option)



\*Photo may include optional equipment.





\*Photo may include optional equipment.

### Cycle Time Improvement

The HX Series provides higher productivity on the site by faster operation.

# WORK MAX, WORTH MAX

## Fuel Efficient System, Allows Great Performance

The HX Series has an eco-friendly, high-performance engine which ensures both excellent fuel efficiency and high power. With outstanding operating performance proven by rigorous tests at various work sites, it will satisfy any customer's needs.



### ECO Gauge

ECO Gauge enable economic operation of machines. The gauge level and color displays engine torque and fuel efficiency level. On top of that, the status of fuel consumption such as average rate and the total amount of fuel consumed are displayed. Hourly and daily based fuel consumption can be checked in the detailed menu as well.



### IPC (Intelligent Power Control)

The IPC controls power control depending on work environments. Its mode can be selected and released on the monitor. On the excavation mode, pump flow can be easily controlled by a lever, reducing fuel consumption.



### Attachment Flow Control

The HX Series improves pump flow rate by independent control of two pumps. It optimizes attachments for effective flow rate setting depending on attachments (ten breaker types and ten crusher types), enabling various operations matching the site environments.

### New Variable Power Control

The HX Series minimizes equipment input and output control signals to improve fuel efficiency. Its three-stage Power mode ensures the highest performance in any operating environment.

\* P (power) mode: Maximizes speed and power of the equipment for heavy load work.

\* S (standard) mode: Optimizes performance and fuel efficiency of the equipment for general load work.

\* E (economy) mode: Improves the control system for light load work.

### Electronic Viscous Fan Clutch

The electronic fan clutch reduces noise during operation by precisely controlling RPM depending on the hydraulic oil and coolant temperature of the working vehicle, and minimizes fuel consumption. It is also possible to shorten the warm up time of hydraulic oil.

### Enlarged Air Inlet with Grill Cover

Enlarged vent hole of the air inlet side cover and fine net grill to prevent penetration of foreign materials further improve durability.



# MORE RELIABLE, MORE SUSTAINABLE

## New Exterior Design for Robustness and Safety

The true value of the HX Series lies in its durability. The robust upper and lower frame structure that can endure external shock and high-load work and the attachments whose performance was proven by rigorous tests further show the real value of the HX Series in tough working environments and promise higher productivity.



### Durable Cooling Module

The HX Series has a durable cooling module that passed stringent tests, demonstrating the highest productivity in tough working environments.

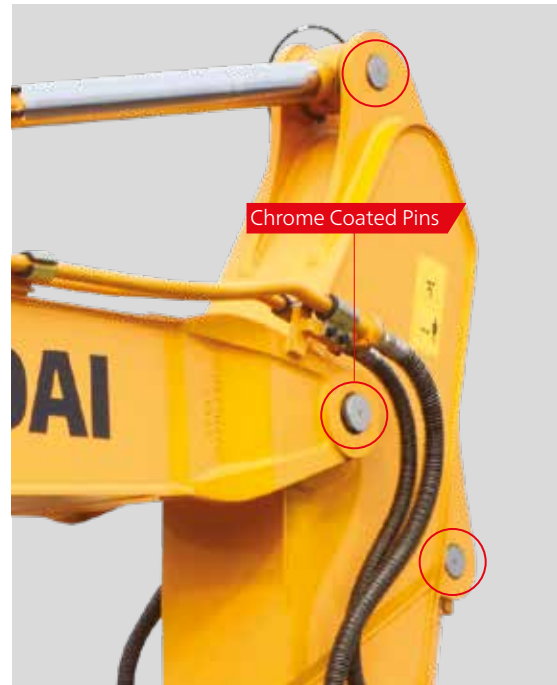

Chrome Coated Pins



### Reinforced Durability of Upper and Lower Structure and Attachments

The upper and lower structure and attachments of the HX Series have higher durability than demanded on the site, as proven through numerous tests including road tests and virtual simulation. The wear resistance of the bucket has been improved by use of new material.

### Reinforced Pin, Bush and Polymer Shim

The HX series improves lubricity of connecting parts between the equipment and attachments. Gaps with attachments are minimized by wear-resistant long-life pins, bushes and polymer shims, supporting the highest performance with invariable durability.



\*Photo may include optional equipment.

### Hi-grade (High-pressure) Hoses

The HX Series uses high-pressure hoses with improved heat and pressure resistance, greatly increasing the durability of the equipment.





310 mm  
(9 Series)

340 mm  
(HX Series)

Cabin space for  
drivers increased by  
**13%**  
(Compared to 9 Series)

\*Photo may include optional equipment.

# INFOTAINMENT FRONTIER

## Enhanced Instrument Panel for Easier Monitoring

Many electronic functions are concentrated on the most convenient spot for operators to ensure work efficiency. The highly-advanced infotainment system, a product of HHI's intensive information technology, enables both productivity and pleasant work at the same time! The HX Series of HHI provides higher value and pleasure to customers.



### Intelligent and Wide Cluster

The 8-inch capacitive-type display (like smartphone display) of the HX Series is 30% larger than the previous model, delivering excellent legibility. The centralized switches on the display allow convenience of checking the urea level and temperature outside the cabin. The audio AUX, air conditioner, heater interoperation and inclination sensor also maximize operator's convenience.

### Wi-Fi Direct with Smart Phone (Miracast)

The Miracast system based on Wi-Fi of the operator's smart phone enables easy and convenient use of various features of the smart phone on the big screen including navigation, web surfing, viewing of videos, and listening to music. (For Android mobile phone now)



### New Audio System

Radio player, USB-based MP3 player, integrated Bluetooth hands-free feature, and built-in microphone allow convenient phone calls while in work and in transit.

### Proportional Auxiliary Hydraulic System

- Opt: Proportional control switch for better speed control
- Enlarge the operation convenience



# MODERN COMFORT, SIMPLE AND SAFE SOLUTION

## New Cabin for More Comfort

Low noise, low vibration, and ergonomic design make the cabin space more comfortable and pleasant! With focus on safety and convenience of operators, the HX Series allows rapid and safe equipment inspection anytime and anywhere, providing an optimal environment for operators to work.

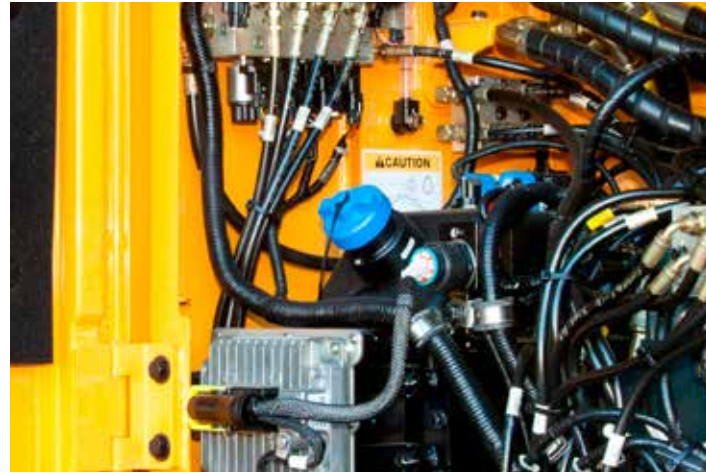

## Easy Access to DEF/AdBlue® Supply System

The DEF/AdBlue® tank is installed inside the tool box and its inlet is remotely located for easy access and convenient supply. Warning of overfill is given by a red lamp signal. The DEF/AdBlue® supply module is attached on the side of the fuel tank for easy maintenance and filter replacement.



## Hi MATE (Remote Management System)

Hi MATE, Hyundai's proprietary remote management system, provides operators and dealer service personnel access to vital service and diagnostic information on the machine from any computer with internet access. Users can pinpoint machine location using digital mapping and set machine work boundaries, reducing the need for multiple service calls. Hi MATE saves time and money for the owner and dealer by promoting preventative maintenance and reducing machine downtime.

\* Operation of the system may be affected by the condition of telecommunication signal



\*Photo may include optional equipment

## Swing Lock System (Option)

Swing Lock System is provided to maintain stability when swing movement needs to be limited, improving operating speed and productivity.

## Fine Swing Control (Option)

Fine swing control is available for customer's convenience when users want to control fine swing.



# SPECIFICATIONS

ENGINE		
Maker / Model	Perkins 1204F	
Type	Water-cooled, 4-cycle diesel, 4-cylinder inline, Direct injection, Turbocharged, Charge and air cooled	
Rated flywheel horse power	SAE J1995 (gross)	92.7 kW (124 HP) at 1,950 rpm
	J1349 (net)	87 kW (116 HP) at 1,950 rpm
	DIN 6271/1 (gross)	92.7 kW (126 PS) at 1,950 rpm
	6271/1 (net)	87 kW (118 PS) at 1,950 rpm
Max. torque	54.0 kgf-m (391 lbf-ft) at 1,400 rpm	
Bore x stroke	105 x 127 mm (4.1" x 5.0")	
Piston displacement	4,400 cc (268.5 cu in)	
Batteries	2 x 12 V x 100 Ah	
Starting motor	24 V - 4.5 kW	
Alternator	24 V - 100 A	

## HYDRAULIC SYSTEM

MAIN PUMP	
Type	Variable displacement tandem axis piston pumps
Max. flow	2 x 126.8 l/min (33.5 US gpm / 27.9 UK gpm)
Sub-pump for pilot circuit	Gear pump

Cross-sensing and fuel saving pump system

HYDRAULIC MOTORS	
Travel	Two speed axial pistons motor with brake valve and parking brake
Swing	Axial piston motor with automatic brake

RELIEF VALVE SETTING	
Implement circuits	350 kgf/cm <sup>2</sup> (4,980 psi)
Travel	350 kgf/cm <sup>2</sup> (4,980 psi)
Power boost (boom, arm, bucket)	380 kgf/cm <sup>2</sup> (5,410 psi)
Swing circuit	285 kgf/cm <sup>2</sup> (4,050 psi)
Pilot circuit	40 kgf/cm <sup>2</sup> (570 psi)
Service valve	Installed

HYDRAULIC CYLINDERS	
No. of cylinder bore x stroke	Boom: 2-105 x 1,105 mm (4.1" X 43.5")
	Arm: 1-115 x 1,138 mm (4.5" X 44.8")
	Bucket: 1-100 x 850 mm (3.9" X 33.1")
	Dozer Blade: 2-100 x 250 mm (3.9" x 9.8")
	2-Piece Boom:
	1st: 2-105 x 995 mm (4.1" x 39.2")
	2nd: 1-145 x 613 mm (5.7" x 24.1")

DRIVES & BRAKES	
Drive method	Fully hydrostatic type
Drive motor	Axial piston motor, in-shoe design
Reduction system	Planetary reduction gear
Max. drawbar pull	12,000 kgf (26,455 lbf)
Max. travel speed (high / low)	5.5 km/hr (3.4 mph) / 3.3 km/hr (2.1 mph)
Gradeability	35° (70%)
Parking brake	Multi wet disc

## CONTROL

Pilot pressure operated joysticks and pedals with detachable lever provide almost effortless and fatigueless operation.	
Pilot control	Two joysticks with one safety lever (LH): Swing and arm (RH): Boom and bucket (ISO)
Traveling and steering	Two levers with pedals
Engine throttle	Electric, Dial type

## SWING SYSTEM

Swing motor	Fixed displacement axial piston motor
Swing reduction	Planetary gear reduction
Swing bearing lubrication	Grease-bathed
Swing brake	Multi wet disc
Swing speed	11.2 rpm

## SERVICE REFILL CAPACITIES ( ): option

	liter	US gal	UK gal
Re-filling			
Fuel tank	265	70.0	58.3
Engine coolant	14.5	3.8	3.2
Engine oil	10.5	2.8	2.3
Swing device	3.5 (2.5)	0.9 (0.7)	0.7 (0.5)
Final drive (each)	2.3	0.6	0.5
Hydraulic system (including tank)	180	47.6	39.6
Hydraulic tank	96	25.4	21.1
DEF/AdBlue® tank	19	5.0	4.2

## UNDERCARRIAGE

The X-leg type center frame is integrally welded with reinforced box-section track frames. The undercarriage includes lubricated rollers, idlers, track adjusters with shock absorbing springs and sprockets and a track chain with double or triple grouser shoes.

Center frame	X - leg type
Track frame	Pentagonal box type
No. of shoes on each side	47 EA
No. of carrier roller on each side	2 EA
No. of track roller on each side	7 EA
No. of rail guard on each side	1 EA

## OPERATING WEIGHT (APPROXIMATE)







Operating weight, including 4,600 mm (15' 1") boom; 2,500 mm (8' 2") arm; SAE heaped 0.52 m<sup>3</sup> (0.68 yd<sup>3</sup>) bucket, lubricant, coolant, full fuel tank, full hydraulic tank and all standard equipments.

OPERATING WEIGHT				
Shoes	Operating weight		Ground pressure	
Type	Width mm (in)	kg (lb)	kgf / cm <sup>2</sup> (psi)	
Triple grouser	500 (20")	HX145LCR	14,950 (32,960)	0.45 (6.40)
		HX145LCR (Dozer type)	15,750 (34,720)	0.47 (6.68)
		HX145LCR	15,160 (33,420)	0.38 (5.40)
	600 (24")	HX145LCR (Dozer type)	15,960 (35,190)	0.40 (5.69)
		HX145LCR	15,370 (33,880)	0.33 (4.69)
		700 (28")	HX145LCR (Dozer type)	16,170 (35,650)

# BUCKET SELECTION GUIDE & DIGGING FORCE

## BUCKETS

All buckets are welded with high-strength steel.

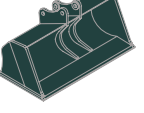
							
SAE heaped m <sup>3</sup> (yd <sup>3</sup> )	0.23 (0.30)	0.40 (0.52)	0.52 (0.68)	0.65 (0.85)	0.71 (0.93)	⊙ 0.45 (0.59)	★ 0.55 (0.72)
		0.46 (0.60)	0.58 (0.76)				

Capacity m <sup>3</sup> (yd <sup>3</sup> )	Width mm (in)	Weight kg (lb)	Recommendation mm (ft.in)							
			4,600 (15' 1") Mono-boom		4,900 (16' 1") 2-Piece boom					
SAE heaped	CECE heaped	Without side cutters	With side cutters	1,900 (6' 3") Arm	2,100 (6' 11") Arm	2,500 (8' 2") Arm	3,000 (9' 10") Arm	2,100 (6' 11") Arm	2,500 (8' 2") Arm	
0.23 (0.30)	0.20 (0.26)	520 (20.5)	620 (24.4)	335 (740)	●	●	●	■	●	●
0.40 (0.52)	0.35 (0.46)	750 (29.5)	850 (33.5)	410 (900)	●	●	●	■	●	●
0.46 (0.60)	0.40 (0.52)	840 (33.1)	940 (37.0)	435 (960)	●	●	●	▲	●	■
0.52 (0.68)	0.45 (0.59)	915 (36.0)	1,015 (40.0)	460 (1,010)	●	●	●	-	■	■
0.58 (0.76)	0.50 (0.65)	1,000 (39.4)	1,100 (43.3)	480 (1,060)	●	●	■	-	■	▲
0.65 (0.85)	0.55 (0.72)	1,105 (43.5)	1,205 (47.4)	500 (1,100)	■	■	▲	-	▲	-
0.71 (0.93)	0.60 (0.78)	1,190 (46.9)	1,290 (50.8)	540 (1,190)	▲	▲	-	-	-	-
■ 0.45 (0.59)	0.40 (0.52)	1,520 (59.8)	-	410 (900)	●	●	■	-	●	■
⊙ 0.55 (0.72)	0.45 (0.59)	1,800 (70.9)	-	585 (1,290)	■	▲	▲	-	■	▲

- Ditching bucket
- ⊙ Slope finishing bucket

- : Applicable for materials with density of 2,000 kg / m<sup>3</sup> (3,370 lb/ yd<sup>3</sup>) or less
- : Applicable for materials with density of 1,600 kg / m<sup>3</sup> (2,700 lb/ yd<sup>3</sup>) or less
- ▲ : Applicable for materials with density of 1,100 kg / m<sup>3</sup> (1,850 lb/ yd<sup>3</sup>) or less

## ATTACHMENT

Booms and arms are welded with a low-stress, full-box section design.

4.6 m (15' 1") Mono-boom and 4.9 m (16' 1") 2-Piece boom and 1.9 m (6' 3"); 2.1 m (6' 11"); 2.5 m (8' 2") & 3.0 m (9' 10") Arms are available.

DIGGING FORCE							
Arm	Length	mm (ft.in)	1,900 (6' 3")	2,100 (6' 11")	2,500 (8' 2")	3,000 (9' 10")	Remarks:
			Weight	kg (lb)	kg (lb)	kg (lb)	
Bucket digging force	SAE	kN	87.3 [94.8]	87.3 [94.8]	87.3 [94.8]	87.3 [94.8]	[ ] : Power Boost
		kgf	8,900 [9,660]	8,900 [9,660]	8,900 [9,660]	8,900 [9,660]	
		lbf	19,620 [21,300]	19,620 [21,300]	19,620 [21,300]	19,620 [21,300]	
	ISO	kN	102 [110.8]	102 [110.8]	102 [110.8]	102 [110.8]	
		kgf	10,400 [11,290]	10,400 [11,290]	10,400 [11,290]	10,400 [11,290]	
		lbf	22,930 [24,890]	22,930 [24,890]	22,930 [24,890]	22,930 [24,890]	
Arm crowd force	SAE	kN	76.5 [83.1]	73.6 [79.9]	62.8 [68.2]	55.9 [60.7]	
		kgf	7,800 [8,470]	7,500 [8,140]	6,400 [6,950]	5,700 [6,190]	
		lbf	17,200 [18,670]	16,530 [17,950]	14,110 [15,320]	12,570 [13,640]	
	ISO	kN	80.4 [87.3]	77.5 [84.1]	65.7 [71.4]	57.9 [62.8]	
		kgf	8,200 [8,900]	7,900 [8,580]	6,700 [7,270]	5,900 [6,410]	
		lbf	18,080 [19,630]	17,420 [18,910]	14,770 [16,040]	13,010 [14,120]	

Note : Arm weight includes bucket cylinder, linkage and pin



# DIMENSIONS & WORKING RANGE

## HX145LCR DIMENSIONS

4.6 m (15' 1") Mono-boom and 2.1 m (6' 11"), 2.5 m (8' 2") & 3.0 m (9' 10") Arm.

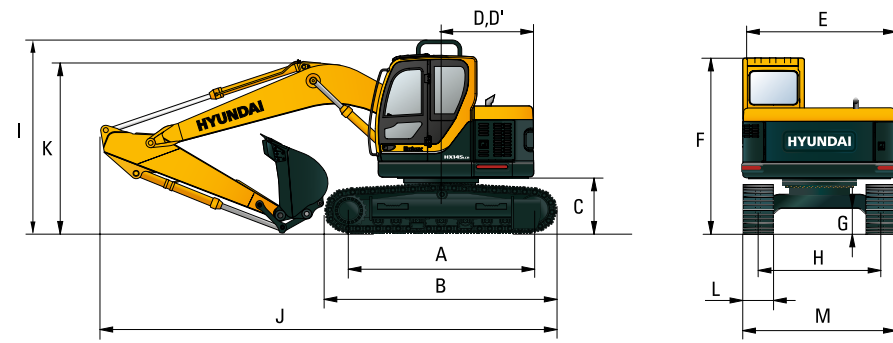

Unit : mm (ft-in)

A	Tumbler distance	3,090 (10' 2")
B	Overall length of crawler	3,798 (12' 4")
C	Ground clearance of counterweight	930 (3' 1")
D	Tail swing radius	1,500 (4' 11")
D'	Rear-end length	1,500 (4' 11")
E	Overall width of upperstructure	2,500 (8' 2")
F	Overall height of cab	2,900 (9' 6")
G	Min. ground clearance	440 (1' 5")
H	Track gauge	2,000 (6' 7")
I	Overall height of guardrail	3,215 (10' 7")

Boom length	4,600 (15' 1")			
Arm length	1,900 (6' 3")	2,100 (6' 11")	2,500 (8' 2")	3,000 (9' 10")
J	7,380 (24' 3")	7,400 (24' 3")	7,360 (24' 2")	7,300 (23' 11")
K	2,630 (8' 8")	2,710 (8' 11")	2,860 (9' 5")	3,210 (10' 6")
L	500 (20")	600 (24")	700 (28")	
M	2,500 (8' 2")	2,600 (8' 6")	2,700 (8' 10")	

## HX145LCR WORKING RANGE

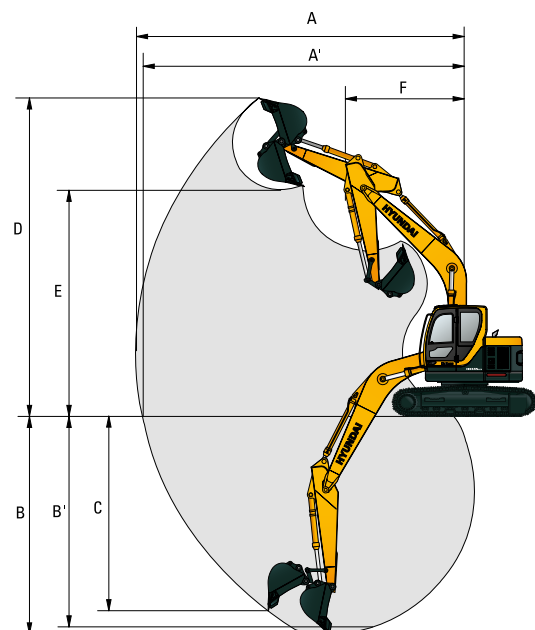

Unit : mm (ft-in)

Boom length	4,600 (15' 1")			
Arm length	1,900 (6' 3")	2,100 (6' 11")	2,500 (8' 2")	3,000 (9' 10")
A	7,730 (25' 4")	7,900 (25' 11")	8,310 (27' 3")	8,770 (28' 9")
A'	7,580 (24' 10")	7,750 (25' 0")	8,170 (26' 10")	8,630 (28' 4")
B	4,890 (16' 1")	5,100 (16' 9")	5,500 (18' 1")	5,990 (19' 8")
B'	4,640 (15' 3")	4,870 (16' 0")	5,290 (17' 4")	5,810 (19' 1")
C	4,400 (14' 5")	4,600 (15' 1")	5,000 (16' 5")	5,400 (17' 9")
D	8,840 (29' 0")	8,970 (29' 5")	9,350 (30' 8")	9,730 (31' 11")
E	6,350 (20' 10")	6,470 (21' 3")	6,850 (22' 6")	7,230 (23' 9")
F	1,860 (6' 1")	2,030 (6' 8")	1,980 (6' 6")	2,260 (7' 5")

# DIMENSIONS & WORKING RANGE

## HX145LCR (DOZER TYPE) DIMENSIONS

4.6 m (15' 1") Mono-boom and 1.9 m (6' 3"), 2.1 m (6' 11"), 2.5 m (8' 2") & 3.0 m (9' 10") Arm.

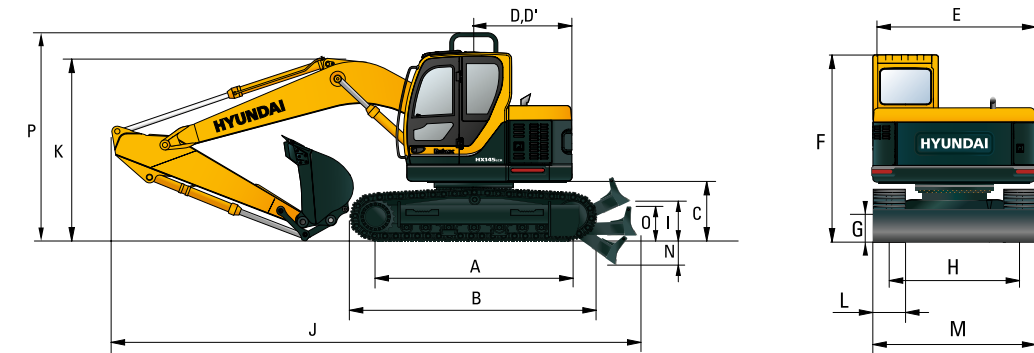

Unit : mm (ft-in)

A	Tumbler distance	3,090 (10' 2")
B	Overall length of crawler	3,798 (12' 4")
C	Ground clearance of counterweight	930 (3' 1")
D	Tail swing radius	1,500 (4' 11")
D'	Rear-end length	1,500 (4' 11")
E	Overall width of upperstructure	2,500 (8' 2")
F	Overall height of cab	2,900 (9' 6")
G	Min. ground clearance	440 (1' 5")
H	Track gauge	2,000 (6' 7")
I	Ground clearance of blade up	420 (1' 4")
N	Depth of blade down	430 (1' 4")
O	Height of blade	575 (1' 8")
P	Overall height of guardrail	3,215 (10' 7")

Boom length	4,600 (15' 1")			
Arm length	1,900 (6' 3")	2,100 (6' 11")	2,500 (8' 2")	3,000 (9' 10")
J	7,840 (25' 9")	7,860 (25' 9")	7,820 (25' 8")	7,760 (25' 6")
K	2,630 (8' 8")	2,710 (8' 11")	2,860 (9' 5")	3,210 (10' 6")
L	500 (20")	600 (24")	700 (28")	
M	2,500 (8' 2")	2,600 (8' 6")	2,700 (8' 10")	

## HX145LCR (DOZER TYPE) WORKING RANGE

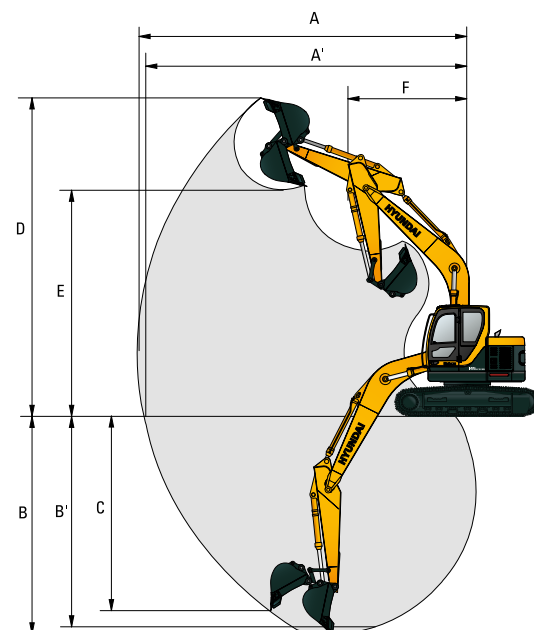

Unit : mm (ft-in)

Boom length	4,600 (15' 1")			
Arm length	1,900 (6' 3")	2,100 (6' 11")	2,500 (8' 2")	3,000 (9' 10")
A	7,730 (25' 4")	7,900 (25' 11")	8,310 (27' 3")	8,770 (28' 9")
A'	7,580 (24' 10")	7,750 (25' 0")	8,170 (26' 10")	8,630 (28' 4")
B	4,890 (16' 1")	5,100 (16' 9")	5,500 (18' 1")	5,990 (19' 8")
B'	4,640 (15' 3")	4,870 (16' 0")	5,290 (17' 4")	5,810 (19' 1")
C	4,400 (14' 5")	4,600 (15' 1")	5,000 (16' 5")	5,400 (17' 9")
D	8,840 (29' 0")	8,970 (29' 5")	9,350 (30' 8")	9,730 (31' 11")
E	6,350 (20' 10")	6,470 (21' 3")	6,850 (22' 6")	7,230 (23' 9")
F	1,860 (6' 1")	2,030 (6' 8")	1,980 (6' 6")	2,260 (7' 5")



# DIMENSIONS & WORKING RANGE

## HX145LCR 2-PIECE DIMENSIONS

4.9 m (16' 1") 2-piece boom and 2.1 m (6' 11"), 2.5 m (8' 2"), 3.05 m (10' 0") & 3.6 m (11' 10") Arm.

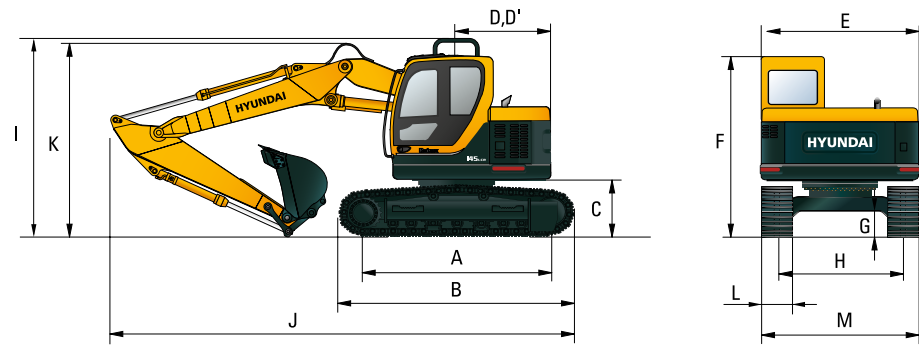

Unit: mm (ft-in)

A	Tumbler distance	3,090 (10' 2")
B	Overall length of crawler	3,798 (12' 4")
C	Ground clearance of counterweight	930 (3' 1")
D	Tail swing radius	1,500 (4' 11")
D'	Rear-end length	1,500 (4' 11")
E	Overall width of upperstructure	2,500 (8' 2")
F	Overall height of cab	2,900 (9' 6")
G	Min. ground clearance	440 (1' 5")
H	Track gauge	2,000 (6' 7")
I	Overall height of guardrail	3,215 (10' 7")

Boom length	4,900 (16' 1") 2-Piece			
Arm length	2,100 (6' 11")	2,500 (8' 2")		
J	Overall length	7,720 (25' 4")	7,690 (25' 3")	
K	Overall height of boom	2,870 (9' 5")	2,900 (9' 6")	
L	Track shoe width	500 (20")	600 (24")	700 (28")
M	Overall width	2,500 (8' 2")	2,600 (8' 6")	2,700 (8' 10")

## HX145LCR 2-PIECE WORKING RANGE

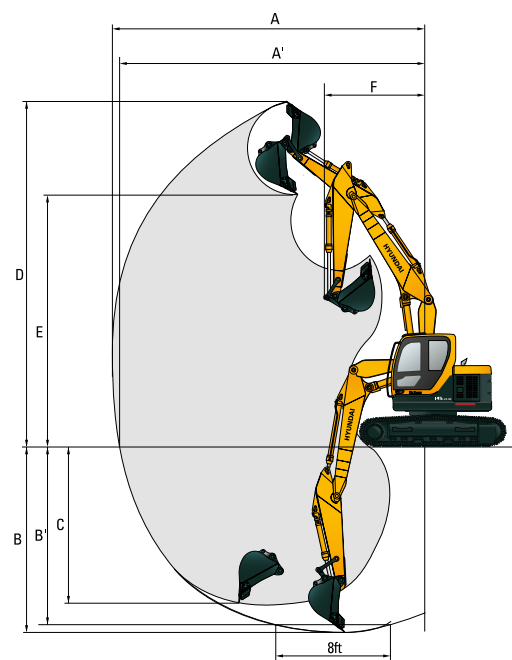

Unit: mm (ft-in)

Boom length	4,900 (16' 1") 2-Piece		
Arm length	2,100 (6' 11")	2,500 (8' 2")	
A	Max. digging reach	8,270 (27' 2")	8,675 (28' 6")
A'	Max. digging reach on ground	8,130 (26' 8")	8,540 (28' 0")
B	Max. digging depth	5,175 (16' 12")	5,580 (18' 4")
B'	Max. digging depth (8' level)	5,060 (16' 7")	5,470 (17' 11")
C	Max. vertical wall digging depth	4,555 (14' 11")	5,015 (16' 5")
D	Max. digging height	9,340 (30' 8")	9,715 (31' 10")
E	Max. dumping height	6,850 (22' 6")	7,230 (23' 9")
F	Min. front swing radius	2,300 (7' 7")	2,250 (7' 5")

# DIMENSIONS & WORKING RANGE

## HX145LCR 2-PIECE (DOZER TYPE) DIMENSIONS

4.9 m (16' 1") 2-piece boom and 2.1 m (6' 11") & 2.5 m (8' 2") Arm.

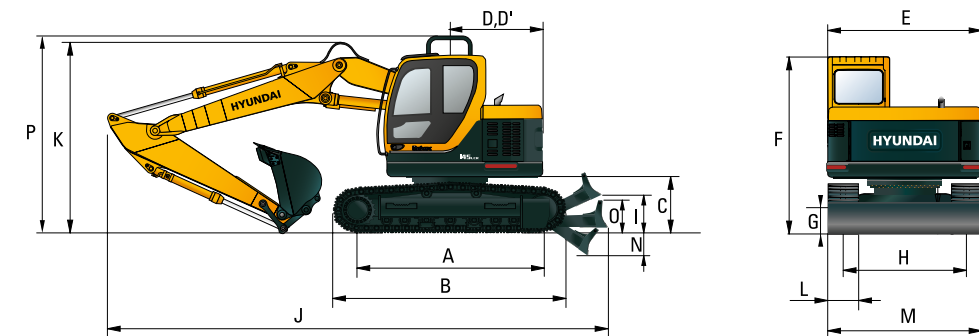

Unit: mm (ft-in)

A	Tumbler distance	3,090 (10' 2")
B	Overall length of crawler	3,798 (12' 4")
C	Ground clearance of counterweight	930 (3' 1")
D	Tail swing radius	1,500 (4' 11")
D'	Rear-end length	1,500 (4' 11")
E	Overall width of upperstructure	2,500 (8' 2")
F	Overall height of cab	2,900 (9' 6")
G	Min. ground clearance	440 (1' 5")
H	Track gauge	2,000 (6' 7")
I	Ground clearance of blade up	410 (1' 4")
N	Depth of blade down	450 (1' 5")
O	Height of blade	575 (1' 8")
P	Overall height of guardrail	3,215 (10' 7")

Boom length	4,900 (16' 1") 2-Piece			
Arm length	2,100 (6' 11")	2,500 (8' 2")		
J	Overall length	8,180 (26' 10")	8,150 (26' 9")	
K	Overall height of boom	2,870 (9' 5")	2,900 (9' 6")	
L	Track shoe width	500 (20")	600 (24")	700 (28")
M	Overall width	2,500 (8' 2")	2,600 (8' 6")	2,700 (8' 10")

## HX145LCR 2-PIECE (DOZER TYPE) WORKING RANGE

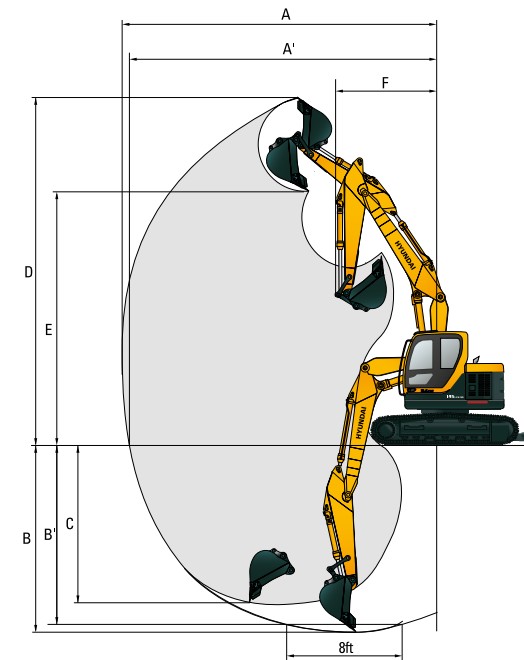

Unit: mm (ft-in)

Boom length	4,900 (16' 1") 2-Piece		
Arm length	2,100 (6' 11")	2,500 (8' 2")	
A	Max. digging reach	8,270 (27' 2")	8,675 (28' 6")
A'	Max. digging reach on ground	8,130 (26' 8")	8,540 (28' 0")
B	Max. digging depth	5,175 (16' 12")	5,580 (18' 4")
B'	Max. digging depth (8' level)	5,060 (16' 7")	5,470 (17' 11")
C	Max. vertical wall digging depth	4,555 (14' 11")	5,015 (16' 5")
D	Max. digging height	9,340 (30' 8")	9,715 (31' 10")
E	Max. dumping height	6,850 (22' 6")	7,230 (23' 9")
F	Min. front swing radius	2,300 (7' 7")	2,250 (7' 5")













# LIFTING CAPACITY











 Rating over-front  Rating over-side or 360 degrees

## HX145LCR











Boom: 4.6 m (15' 1") / Arm: 1.9 m (6' 3") / Bucket: 0.52 m<sup>3</sup> (0.68 yd<sup>3</sup>) SAE heaped / Shoe: 600 mm (24") triple grouser with 2,800 kg (6,170 lb) counterweight.

Load point height m (ft)	Load radius								At max. reach		
	1.5 m (5 ft)		3.0 m (10 ft)		4.5 m (15 ft)		6.0 m (20 ft)		Capacity		Reach
											m (ft)
6.0 m (20 ft)	kg										
	lb										
4.5 m (15 ft)	kg										
	lb										
3.0 m (10 ft)	kg										
	lb										
1.5 m (5 ft)	kg										
	lb										
Ground Line	kg										
	lb										
-1.5 m (-5 ft)	kg										
	lb										
-3.0 m (-10 ft)	kg										
	lb										

Boom: 4.6 m (15' 1") / Arm: 2.1 m (6' 11") / Bucket: 0.52 m<sup>3</sup> (0.68 yd<sup>3</sup>) SAE heaped / Shoe: 600 mm (24") triple grouser with 2,800 kg (6,170 lb) counterweight.

Load point height m (ft)	Load radius								At max. reach		
	1.5 m (5 ft)		3.0 m (10 ft)		4.5 m (15 ft)		6.0 m (20 ft)		Capacity		Reach
											m (ft)
6.0 m (20 ft)	kg										
	lb										
4.5 m (15 ft)	kg										
	lb										
3.0 m (10 ft)	kg										
	lb										
1.5 m (5 ft)	kg										
	lb										
Ground Line	kg										
	lb										
-1.5 m (-5 ft)	kg										
	lb										
-3.0 m (-10 ft)	kg										
	lb										

Boom: 4.6 m (15' 1") / Arm: 2.5 m (8' 2") / Bucket: 0.52 m<sup>3</sup> (0.68 yd<sup>3</sup>) SAE heaped / Shoe: 600 mm (24") triple grouser with 2,800 kg (6,170 lb) counterweight.

Load point height m (ft)	Load radius								At max. reach		
	1.5 m (5 ft)		3.0 m (10 ft)		4.5 m (15 ft)		6.0 m (20 ft)		Capacity		Reach
											m (ft)
6.0 m (20 ft)	kg										
	lb										
4.5 m (15 ft)	kg										
	lb										
3.0 m (10 ft)	kg										
	lb										
1.5 m (5 ft)	kg										
	lb										
Ground Line	kg										
	lb										
-1.5 m (-5 ft)	kg										
	lb										
-3.0 m (-10 ft)	kg										
	lb										
-4.5 m (-15 ft)	kg										
	lb										

1. Lifting capacity are based on SAE J1097 and ISO 10567.  
2. Lifting capacity of the HX series does not exceed 75% of tipping load with the machine on firm, level ground or 87% of full hydraulic capacity.













3. The load point is a hook (standard equipment) located on the back of the bucket.  
4. (\*) indicates load limited by hydraulic capacity.

# LIFTING CAPACITY











 Rating over-front  Rating over-side or 360 degrees

## HX145LCR











Boom: 4.6 m (15' 1") / Arm: 3.0 m (9' 10") / Bucket: 0.52 m<sup>3</sup> (0.68 yd<sup>3</sup>) SAE heaped / Shoe: 600 mm (24") triple grouser with 2,800 kg (6,170 lb) counterweight.

Load point height m (ft)	Load radius										At max. reach		
	1.5 m (5 ft)		3.0 m (10 ft)		4.5 m (15 ft)		6.0 m (20 ft)		7.5 m (25 ft)		Capacity		Reach
													m (ft)
6.0 m (20 ft)	kg												
	lb												
4.5 m (15 ft)	kg												
	lb												
3.0 m (10 ft)	kg												
	lb												
1.5 m (5 ft)	kg												
	lb												
Ground Line	kg												
	lb												
-1.5 m (-5 ft)	kg												
	lb												
-3.0 m (-10 ft)	kg												
	lb												
-4.5 m (-15 ft)	kg												
	lb												

Boom: 4.6 m (15' 1") / Arm: 1.9 m (6' 3") / Bucket: 0.52 m<sup>3</sup> (0.68 yd<sup>3</sup>) SAE heaped / Shoe: 600 mm (24") triple grouser with 2,800 kg (6,170 lb) counterweight. Dozer Blade up

Load point height m (ft)	Load radius								At max. reach		
	1.5 m (5 ft)		3.0 m (10 ft)		4.5 m (15 ft)		6.0 m (20 ft)		Capacity		Reach
											m (ft)
6.0 m (20 ft)	kg										
	lb										
4.5 m (15 ft)	kg										
	lb										
3.0 m (10 ft)	kg										
	lb										
1.5 m (5 ft)	kg										
	lb										
Ground Line	kg										
	lb										
-1.5 m (-5 ft)	kg										
	lb										
-3.0 m (-10 ft)	kg										
	lb										

Boom: 4.6 m (15' 1") / Arm: 1.9 m (6' 3") / Bucket: 0.52 m<sup>3</sup> (0.68 yd<sup>3</sup>) SAE heaped / Shoe: 600 mm (24") triple grouser with 2,800 kg (6,170 lb) counterweight. Dozer Blade down

Load point height m (ft)	Load radius								At max. reach		
	1.5 m (5 ft)		3.0 m (10 ft)		4.5 m (15 ft)		6.0 m (20 ft)		Capacity		Reach
											m (ft)
6.0 m (20 ft)	kg										
	lb										
4.5 m (15 ft)	kg										
	lb										
3.0 m (10 ft)	kg										
	lb										
1.5 m (5 ft)	kg										
	lb										
Ground Line	kg										
	lb										
-1.5 m (-5 ft)	kg										
	lb										
-3.0 m (-10 ft)	kg										
	lb										

1. Lifting capacity are based on SAE J1097 and ISO 10567.  
2. Lifting capacity of the HX series does not exceed 75% of tipping load with the machine on firm, level ground or 87% of full hydraulic capacity.

3. The load point is a hook (standard equipment) located on the back of the bucket.  
4. (\*) indicates load limited by hydraulic capacity.







# LIFTING CAPACITY

Rating over-front Rating over-side or 360 degrees

## HX145LCR 2-PIECE BOOM

Boom: 4.9 m (16' 1") / Arm: 2.1 m (6' 11") / Bucket: 0.52 m<sup>3</sup> (0.68 yd<sup>3</sup>) SAE heaped / Shoe: 600 mm (24") triple grouser with 2,800 kg (6,170 lb) counterweight.

Load point height m (ft)	Load radius								At max. reach		
	1.5 m (5 ft)		3.0 m (10 ft)		4.5 m (15 ft)		6.0 m (20 ft)		Capacity	Reach	
6.0 m (20 ft)	kg *3480	*3480	*3700	*3700	*3490	3470			3100	1770	6.46
	lb *7670	*7670	*8160	*8160	*7690	7650			6830	3900	(21.2)
4.5 m (15 ft)	kg *3410	*3410	*4460	*4460	*3800	3350	*3410	1980	2430	1330	7.33
	lb *7520	*7520	*9830	*9830	*8380	7390	*7520	4370	5360	2930	(24.0)
3.0 m (10 ft)	kg		*6790	5990	*4560	3090	3360	1880	2140	1140	7.77
	lb		*14970	13210	*10050	6810	7410	4140	4720	2510	(25.5)
1.5 m (5 ft)	kg				5170	2790	3230	1760	2060	1070	7.87
	lb				11400	6150	7120	3880	4540	2360	(25.8)
Ground Line	kg		*5960	4890	4950	2600	3120	1660	2140	1110	7.63
	lb		*13140	10780	10910	5730	6880	3660	4720	2450	(25.0)
-1.5 m (-5 ft)	kg		*8260	4900	4880	2540	3080	1620			
	lb		*18210	10800	10760	5600	6790	3570			

Boom: 4.9 m (16' 1") / Arm: 2.5 m (8' 2") / Bucket: 0.52 m<sup>3</sup> (0.68 yd<sup>3</sup>) SAE heaped / Shoe: 600 mm (24") triple grouser with 2,800 kg (6,170 lb) counterweight.

Load point height m (ft)	Load radius								At max. reach				
	1.5 m (5 ft)		3.0 m (10 ft)		4.5 m (15 ft)		6.0 m (20 ft)		7.5 m (25 ft)		Capacity	Reach	
6.0 m (20 ft)	kg *2640	*2640	*3000	*3000	*3110	*3110	*1990	*1990			2700	1510	6.96
	lb *5820	*5820	*6610	*6610	*6860	*6860	*4390	*4390			5950	3330	(22.8)
4.5 m (15 ft)	kg *2270	*2270	*3170	*3170	*3440	3390	*3140	1990			2170	1160	7.77
	lb *5000	*5000	*6990	*6990	*7580	7470	*6920	4390			4780	2560	(25.5)
3.0 m (10 ft)	kg		*6030	*6030	*4220	3120	3370	1880			1930	1000	8.18
	lb		*13290	*13290	*9300	6880	7430	4140			4250	2200	(26.8)
1.5 m (5 ft)	kg		*7680	5260	*5120	2800	3210	1740	2190	1140	1860	940	8.27
	lb		*16930	11600	*11290	6170	7080	3840	4830	2510	4100	2070	(27.1)
Ground Line	kg		*6290	4850	4930	2570	3090	1620			1920	970	8.05
	lb		*13870	10690	10870	5670	6810	3570			4230	2140	(26.4)
-1.5 m (-5 ft)	kg		*8510	4800	4810	2470	3020	1570			2170	1120	7.49
	lb		*18760	10580	10600	5450	6660	3460			4780	2470	(24.6)
-3.0 m (-10 ft)	kg				4840	2500							
	lb				10670	5510							

Boom: 4.9 m (16' 1") / Arm: 2.1 m (6' 11") / Bucket: 0.52 m<sup>3</sup> (0.68 yd<sup>3</sup>) SAE heaped / Shoe: 600 mm (24") triple grouser with 2,800 kg (6,170 lb) counterweight. Dozer Blade up

Load point height m (ft)	Load radius								At max. reach		
	1.5 m (5 ft)		3.0 m (10 ft)		4.5 m (15 ft)		6.0 m (20 ft)		Capacity	Reach	
6.0 m (20 ft)	kg *3480	*3480	*3700	*3700	*3490	*3490			*3150	1890	6.46
	lb *7670	*7670	*8160	*8160	*7690	*7690			*6940	4170	(21.2)
4.5 m (15 ft)	kg *3410	*3410	*4460	*4460	*3800	3540	*3410	2110	2540	1440	7.33
	lb *7520	*7520	*9830	*9830	*8380	7800	*7520	4650	5600	1370	(24.0)
3.0 m (10 ft)	kg		*6790	6330	*4560	3280	3500	2010	2240	1240	7.77
	lb		*14970	13960	*10050	7230	7720	4430	4940	2730	(25.5)
1.5 m (5 ft)	kg				5380	2980	3370	1890	2160	1170	7.87
	lb				11860	6570	7430	4170	4760	2580	(25.8)
Ground Line	kg		*5960	5230	5160	2790	3260	1790	2240	1210	7.63
	lb		*13140	11530	11380	6150	7190	3950	4940	2670	(25.0)
-1.5 m (-5 ft)	kg		*8260	5240	5080	2720	3220	1760			
	lb		*18210	11550	11200	6000	7100	3880			

- Lifting capacity are based on SAE J1097 and ISO 10567.
- Lifting capacity of the HX series does not exceed 75% of tipping load with the machine on firm, level ground or 87% of full hydraulic capacity.
- The load point is a hook (standard equipment) located on the back of the bucket.
- (\*) indicates load limited by hydraulic capacity.

# LIFTING CAPACITY

Rating over-front Rating over-side or 360 degrees

## HX145LCR 2-PIECE BOOM

Boom: 4.9 m (16' 1") / Arm: 2.1 m (6' 11") / Bucket: 0.52 m<sup>3</sup> (0.68 yd<sup>3</sup>) SAE heaped / Shoe: 600 mm (24") triple grouser with 2,800 kg (6,170 lb) counterweight. Dozer Blade down

Load point height m (ft)	Load radius								At max. reach		
	1.5 m (5 ft)		3.0 m (10 ft)		4.5 m (15 ft)		6.0 m (20 ft)		Capacity	Reach	
6.0 m (20 ft)	kg *3480	*3480	*3700	*3700	*3490	*3490			*3150	2120	6.46
	lb *7670	*7670	*8160	*8160	*7690	*7690			*6940	4670	(21.2)
4.5 m (15 ft)	kg *3410	*3410	*4460	*4460	*3800	*3800	*3410	2370	*3070	1630	7.33
	lb *7520	*7520	*9830	*9830	*8380	*8380	*7520	5220	*6770	3590	(24.0)
3.0 m (10 ft)	kg		*6790	*6790	*4560	3680	*3670	2270	*3060	1420	7.77
	lb		*14970	*14970	*10050	8110	*8090	5000	*6750	3130	(25.5)
1.5 m (5 ft)	kg				*5380	3380	*4010	2140	*3060	1340	7.87
	lb				*11860	7450	*8840	4720	*6750	2950	(25.8)
Ground Line	kg		*5960	*5960	*5800	3180	*4200	2050	*3050	1400	7.63
	lb		*13140	*13140	*12790	7010	*9260	4520	*6720	3090	(25.0)
-1.5 m (-5 ft)	kg		*8260	6080	*5630	3120	*4010	2010			
	lb		*18210	13400	*12410	6880	*8840	4430			

Boom: 4.9 m (16' 1") / Arm: 2.5 m (8' 2") / Bucket: 0.52 m<sup>3</sup> (0.68 yd<sup>3</sup>) SAE heaped / Shoe: 600 mm (24") triple grouser with 2,800 kg (6,170 lb) counterweight. Dozer Blade up

Load point height m (ft)	Load radius								At max. reach				
	1.5 m (5 ft)		3.0 m (10 ft)		4.5 m (15 ft)		6.0 m (20 ft)		7.5 m (25 ft)		Capacity	Reach	
6.0 m (20 ft)	kg *2640	*2640	*3000	*3000	*3110	*3110	*1990	*1990			2820	1630	6.96
	lb *5820	*5820	*6610	*6610	*6860	*6860	*4390	*4390			6220	3590	(22.8)
4.5 m (15 ft)	kg *2280	*2280	*3180	*3180	*3450	*3450	*3150	2120			2280	1260	7.77
	lb *5030	*5030	*7010	*7010	*7610	*7610	*6940	4670			5030	2780	(25.5)
3.0 m (10 ft)	kg		*6030	*6030	*4230	3310	*3450	2010			2030	1090	8.18
	lb		*13290	*13290	*9330	7300	*7610	4430			4480	2400	(26.8)
1.5 m (5 ft)	kg		*7680	5600	*5120	3000	3360	1880			1950	1030	8.27
	lb		*16930	12350	*11290	6610	7410	4140	*2260	1240	4300	2270	(27.1)
Ground Line	kg		*6290	5200	5140	2760	3230	1760			2020	1070	8.05
	lb		*13870	11460	11330	6080	7120	3880			4450	2360	(26.4)
-1.5 m (-5 ft)	kg		*8510	5140	5030	2670	3160	1700			2280	1220	7.49
	lb		*18760	11330	11090	5890	6970	3750			5030	2690	(24.6)
-3.0 m (-10 ft)	kg				*4990	2690							
	lb				*11000	5930							

Boom: 4.9 m (16' 1") / Arm: 2.5 m (8' 2") / Bucket: 0.52 m<sup>3</sup> (0.68 yd<sup>3</sup>) SAE heaped / Shoe: 600 mm (24") triple grouser with 2,800 kg (6,170 lb) counterweight. Dozer Blade down

Load point height m (ft)	Load radius								At max. reach				
	1.5 m (5 ft)		3.0 m (10 ft)		4.5 m (15 ft)		6.0 m (20 ft)		7.5 m (25 ft)		Capacity	Reach	
6.0 m (20 ft)	kg *2640	*2640	*3000	*3000	*3110	*3110	*1990	*1990			*2890	1840	6.96
	lb *5820	*5820	*6610	*6610	*6860	*6860	*4390	*4390			*6370	4060	(22.8)
4.5 m (15 ft)	kg *2280	*2280	*3180	*3180	*3450	*3450	*3150	2390			*2830	1440	7.77
	lb *5030	*5030	*7010	*7010	*7610	*7610	*6940	5270			*6240	3170	(25.5)
3.0 m (10 ft)	kg		*6030	*6030	*4230	3730	*3450	2270			*2820	1260	8.18
	lb		*13290	*13290	*9330	8220	*7610	5000			*6220	2780	(26.8)
1.5 m (5 ft)	kg		*7680	6460	*5120	3400	*3840	2130			*2830	1200	8.27
	lb		*16930	14240	*11290	7500	*8470						







ENGINE	STD	OPT
Perkins 1204F engine	●	
<b>HYDRAULIC SYSTEM</b>		
<b>Intelligent Power Control (IPC)</b>		
3-power mode, 2-work mode, user mode	●	
Variable Power Control	●	
Pump Flow Control	●	
Attachment Mode Flow Control		●
Engine Auto Idle	●	
Engine Auto Shutdown Control		●
Electronic Fan Control	●	
<b>CABIN &amp; INTERIOR</b>		
<b>ISO Standard cabin</b>		
Rise-up type windshield wiper	●	
Radio / USB player	●	
Handsfree mobile phone system with USB	●	
12 volt power outlet (24V DC to 12V DC converter)	●	
Electric horn	●	
All-weather steel cab with 360° visibility	●	
Safety glass windows	●	
Sliding fold-in front window	●	
Sliding side window (LH)	●	
Lockable door	●	
Hot & cool box	●	
Storage compartment & Ashtray	●	
Transparent cabin roof-cover	●	
Sun visor	●	
Door and cab locks, one key	●	
Mechanical suspension seat with heater	●	
Pilot-operated slidable joystick	●	
Console box height adjust system	●	
<b>Automatic climate control</b>		
Air conditioner & heater	●	
Defroster	●	
Starting Aid (air grid heater) for cold weather	●	
<b>Centralized monitoring</b>		
8" LCD display	●	
Engine speed or Trip meter/Accel.	●	
Engine coolant temperature gauge	●	
Max power	●	
Low speed/High speed	●	
Auto idle	●	
Overload	●	
Check Engine	●	
Air cleaner clogging	●	
Indicators	●	
ECO Gauges	●	
Fuel level gauge	●	
Hyd. oil temperature gauge	●	
Warnings	●	
Communication error	●	
Low battery	●	
Clock	●	
Cabin lights	●	
Cabin front window rain guard	●	
<b>Seat</b>		
Adjustable air suspension seat with heater		●
<b>Cabin FOPS/FOG (ISO/DIS 10262) Level 2</b>		
FOPS (Falling Object Protective Structure) · ISO 3449 Level 2		●
FOG (Falling Object Guard)		●
<b>Cabin ROPS (ISO 12117-2)</b>		
ROPS (Roll Over Protective Structure)	●	

SAFETY	STD	OPT
Battery master switch	●	
Rearview camera	●	
Four front working lights	●	
Travel alarm	●	
Rear work lamp		●
Beacon lamp		●
Automatic swing brake	●	
Boom holding system	●	
Arm holding system	●	
Safety lock valve for boom cylinder with overload warning device	●	
Safety lock valve for arm cylinder		●
Swing Lock System		●
Two outside rearview mirrors	●	
<b>OTHER</b>		
<b>Booms</b>		
4.6 m; 15' 1" Mono	●	
4.1 m m; 13' 5" Mono		●
4.9 m; 16' 1" 2-Piece		●
<b>Arms</b>		
1.9 m; 6' 3"		●
2.1 m; 6' 11"		●
2.5 m; 8' 2"	●	
3.0 m; 9' 11"		●
Removable clean-out dust net for cooler	●	
Removable reservoir tank	●	
Fuel pre-filter	●	
Self-diagnostics system	●	
Hi MATE (Remote Management System)	●	
Batteries (2 x 12 V x 100 Ah)	●	
Fuel filler pump (50 l/min)	●	
Single-acting piping kit (breaker, etc.)		●
Double-acting piping kit (clamshell, etc.)	●	
Rotating Piping Kit		●
Quick coupler piping		●
Quick coupler		●
Accumulator for lowering work equipment	●	
Pattern change valve (2 patterns)		●
Fine Swing Control System		●
Tool kit		●
<b>UNDERCARRIAGE</b>		
Lower frame under cover (Additional)		●
Lower frame under cover (Normal)	●	
<b>Track shoes</b>		
Triple grouser shoe (600 mm; 24")	●	
Triple grouser shoe (700 mm; 28")		●
Track rail guard		●

STD = Standard  
OPT = Optional

- \* Standard and optional equipment may vary. Contact your Hyundai dealer for more information. The machine may vary according to International standards.
- \* The photos may include attachments and optional equipment that are not available in your area.
- \* Materials and specifications are subject to change without advance notice.
- \* All imperial measurements rounded off to the nearest pound or inch.
- \* The air conditioning system on this machine contains the fluorinated greenhouse gas refrigerant HFC-134a (Global Warming Potential = 1430). The system contains 0.75 kg of refrigerant which has a CO<sub>2</sub> equivalent of 1.0725 metric tonne.



PLEASE CONTACT

Hyundai Construction Equipment Europe nv

Hyundailaan 4, 3980 Tessenderlo, Belgium Tel: (32) 14-56-2200 Fax: (32) 14-59-3405 www.hyundai.eu

EN - 2018.02 Rev 3