

MOVING YOU FURTHER

HX140LC

With Tier 4 final / Stage IV Engine installed



*Photo may include optional equipment.

Net Power

SAE J1349 / 95 kW (127 HP) at 2,200 rpm

Gross Power

SAE J1995 / 97 kW (130 HP) at 2,200 rpm

Travel Speed

5.6 km/hr (3.5 mph) / 3.3 km/hr (2.1 mph)

Operating Weight

14,050 kg (30,975 lb)



THE HX SERIES EXCAVATORS are products of HCE's spirit of initiative, creativity, and strong drive. HCE's engineers, who are the best in the industry, have worked tirelessly to offer a zero-defect product. The new HX Series reflects customers' needs in the field gleaned by thorough monitoring. They maximize fuel efficiency and performance proven by rigorous field tests and quality control.



- 1. Crawler excavators
- 2. Wheel excavators
- 3. Wheel loaders

*Photo may include optional equipment.

RULE THE GROUND

The HX series exceeds customers' expectation!
Become a true leader on the ground with HCE's HX series.

HX140LC



WORK MAX, WORTH MAX

- ECO Gauge
- IPC (Intelligent Power Control)
- New Variable Power Control
- Attachment Flow Control (Option)
- New Cooling System with Increased Air Flow
- Enlarged Air Inlet with Grill Cover
- Cycle Time Improvement



MORE RELIABLE, MORE SUSTAINABLE

- Reinforced Pin, Bush and Polymer Shim
- Durable Cooling Module
- Reinforced Durability of Upper and Lower Structure and Attachments
- Hi-grade (High-pressure) Hoses



INFOTAINMENT FRONTIER

- Intelligent and Wide Cluster
- Haptic Control
- Wi-Fi Direct with Smart Phone (Miracast)
- Proportional Auxiliary Hydraulic System
- New Audio System
- New Air Conditioning System



MODERN COMFORT, SIMPLE AND SAFE SOLUTION

- AAVM (Advanced Around View Monitoring) Camera System (Option)
- RH Side View Camera (Option) **NEW**
- Easy Access to DEF/AdBlue® Supply System
- Hi MATE (Remote Management System)
- Swing Lock System (Option)
- Fine Swing Control (Option)



*Photo may include optional equipment.

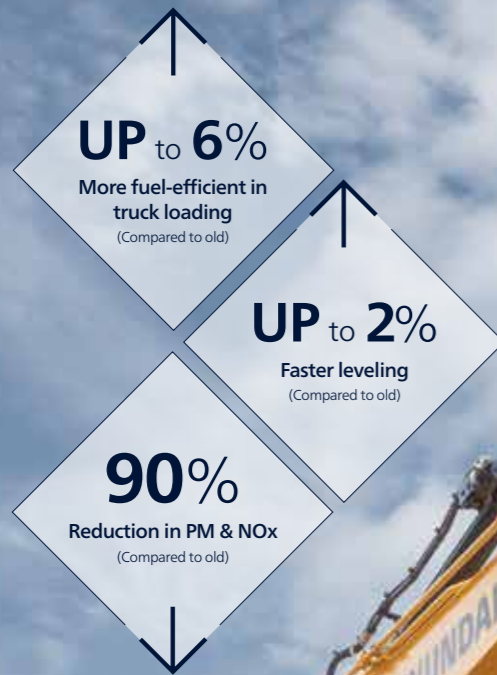

WORK MAX, WORTH MAX

Fuel Efficient System, Allows Great Performance

The HX Series has an eco-friendly, high-performance engine which ensures both excellent fuel efficiency and high power. With outstanding operating performance proven by rigorous tests at various work sites, it will satisfy any customer's needs.



ECO Colored Gauge

ECO Gauge enable economic operation of machines. The gauge level and color displays engine torque and fuel efficiency level. On top of that, the status of fuel consumption such as average rate and the total amount of fuel consumed are displayed. Hourly and daily based fuel consumption can be checked in the detailed menu as well.



IPC (Intelligent Power Control)

The IPC controls power control depending on work environments. Its mode can be selected and released on the monitor. On the excavation mode, pump flow can be easily controlled by a switch valve, reducing fuel consumption.

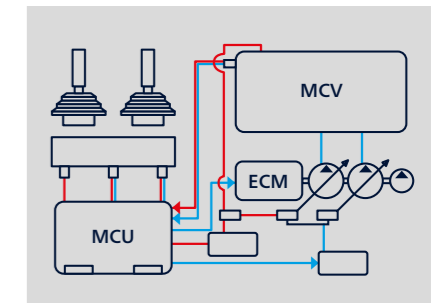

New Variable Power Control

The HX Series minimizes equipment input and output control signals to improve fuel efficiency. Its three-stage Power mode ensures the highest performance in any operating environment.

- * P (power) mode: Maximizes speed and power of the equipment for heavy load work.
- * S (standard) mode: Optimizes performance and fuel efficiency of the equipment for general load work.
- * E (economy) mode: Improves the control system for light load work.

*Photo may include optional equipment.

Fuel Rate Information



Attachment Flow Control (Option)

The HX Series improves pump flow rate by independent control of two pumps. It optimizes attachments for effective flow rate setting depending on attachments (ten breaker types and ten crusher types), enabling various operations matching the site environments.



New Cooling System with Increased Air Flow

With the three-floor stacked cooling module improving air inflow, the HX Series provides excellent cooling performance by increasing heat dissipation and can be easily cleaned.



Enlarged Air Inlet with Grill Cover

Enlarged vent hole of the air inlet side cover and fine net grill to prevent penetration of foreign materials further improve durability.



Cycle Time Improvement

The HX Series provides higher productivity on the site by faster operation: it loads trucks up to 6% faster and levels up to 2% faster than the 9 Series.

MORE RELIABLE, MORE SUSTAINABLE

New Exterior Design for Robustness and Safety

The true value of the HX Series lies in its durability. The robust frame structure and the attachments show the real value of the HX Series in tough working environments and promise higher productivity.

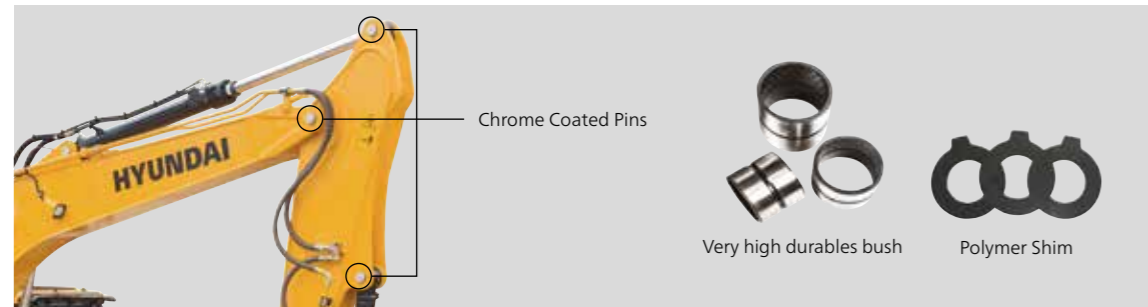

Reinforced Pin, Bush and Polymer Shim

The HX series improves lubricity of connecting parts between the equipment and attachments. Gaps with attachments are minimized by wear-resistant long-life pins, bushes and polymer shims, supporting the highest performance with invariable durability.



Durable Cooling Module

The HX series has a durable cooling module that passed stringent tests, demonstrating the highest productivity in tough working environments.



Reinforced Durability of Upper and Lower Structure and Attachments

The upper and lower structure and attachments of the HX Series have higher durability than demanded on the site, as proven through numerous tests including road tests and virtual simulation. The wear resistance of the bucket has been improved by use of new material.



Hi-grade (High-pressure) Hoses

The HX Series uses high-pressure hoses with improved heat and pressure resistance, greatly increasing the durability of the equipment.



*Photo may include optional equipment.

INFOTAINMENT FRONTIER

Improved Instrument Panel for Easier Monitoring

Many electronic functions are concentrated in the most convenient spot for operators to improve work efficiency. The highly-advanced infotainment system, a product of HCE's intensive information technology development, enables both productivity and comfort while working! The HX Series is designed with the operator in mind.



Intelligent and Wide Cluster

The 8-inch capacitive-type display (like smartphone display) of the HX Series is 15% larger than the previous model, delivering excellent legibility. The centralized switches on the display allow convenience of checking the urea level and temperature outside the cabin. The audio AUX, air conditioner, heater interoperation, wiper, lamps, overload warnings, travel alarm and inclination sensor also maximize operator's convenience.



Haptic Control

The integrated jog shuttle-type haptic controller applies to the accelerator, remote air conditioner controller and operation of the cluster, allowing convenient operation. In the event of failure of the haptic switch, the emergency mode is activated on the cluster to ensure fail-safe function.



New Audio System

Radio player, USB-based MP3 player, integrated Bluetooth hands-free feature, and built-in microphone allow convenient phone calls while in work and in transit. The radio player was moved to the right side from the rear, allowing easier access.

Wi-Fi Direct with Smart Phone (Miracast)

The Miracast system based on Wi-Fi of the operator's smart phone enables easy and convenient use of various features of the smart phone on the big screen including navigation, web surfing, viewing of videos, and listening to music. (For Android mobile phone now)



Proportional Auxiliary Hydraulic System

- Opt: Proportional control switch for better speed control
- Enlarge the operation convenience



New Front Side Air-conditioning System

The ventilation is designed for both warm and cool air reaching to operators' faces. It could help operators create more neat and enjoyable atmosphere through indoor air circulation.

MODERN COMFORT, SIMPLE AND SAFE SOLUTION

New Cabin for More Comfort

Low noise, low vibration, and ergonomic design make the cabin space more comfortable and pleasant! With focus on safety and convenience of operators, the HX Series allows rapid and safe equipment inspection anytime and anywhere, providing an optimal environment for operators to work.



AAVM (Advanced Around View Monitoring) Camera System (Option)

The HX Series has a state-of-the-art AAVM video camera system to secure field of vision for operators in all directions, thereby preventing accidents. Operators can easily check the workplace in the front, rear and to the right and left.

* AAVM (Advanced Around View Monitoring): Secure field of vision in all directions by nine views including 3D bird's eye view and 2D/4CH view.

* IMOD (Intelligent Moving Object Detection): Inform when people or dangerous objects are detected within the range of operation (recognition distance: 5 m).

RH Side View Camera (Option)

HiMATE

It's convenient, easy and valuable

Hi MATE, Hyundai's newly developed remote management system, utilizes GPS-satellite technology to provide customers with the highest level of service and product support available. Hi MATE enables users to remotely evaluate machine performance, access diagnostic information and verify machine locations at the touch of a button.

What are the Benefits?



Increase Productivity

It helps you operate machines efficient. You can check the difference between total engine hours and actual working hours. See how productive your machines are and plan any required cost saving solutions. Hi MATE offers working information such as working / idling hours, fuel consumption and rate.



Convenient and Easy Monitoring

There is not much to do to monitor your machines. Just log on to the Hi MATE website or mobile application. Hi MATE allows you to watch your machines whenever and wherever you are.



Security

Protect your machines from theft or unauthorized usage with Hi MATE. If the machine moves out of the Geo-fence boundary, you will get alerts.



*Photo may include optional equipment.

Easy Access to DEF/AdBlue® Supply System

The DEF/AdBlue® tank is installed inside the tool box and its inlet is remotely located for easy access and convenient supply. Warning of overfill is given by a red lamp signal. The DEF/AdBlue® supply module is attached on the side of the fuel tank for easy maintenance and filter replacement.

Swing Lock System (Option)

Swing Lock System is provided to maintain stability when swing movement needs to be limited, improving operating speed and productivity.

Fine Swing Control (Option)

Fine swing control is available for customer's convenience when users want to control fine swing.

SPECIFICATIONS

ENGINE

Maker / Model	Cummins QSF 3.8		
Type	4-cycle turbocharged, charger air cooled diesel engine		
Rated flywheel horse power	SAE	J1995 (gross)	97 kW (130 HP) at 2,200 rpm
		J1349 (net)	95 kW (127 HP) at 2,200 rpm
	DIN	6271/1 (gross)	97 kW (132 PS) at 2,200 rpm
		6271/1 (net)	95 kW (129 PS) at 2,200 rpm
Max. torque	50 kgf-m (360 lbf-ft) at 1,600 rpm		
Bore x stroke	102 x 115 mm (4.02" x 4.53")		
Piston displacement	3,800 cc (229 cu in)		
Batteries	2 x 12 V x 100 Ah		
Starting motor	24 V - 4.8 kW		
Alternator	28 V - 70 A		

HYDRAULIC SYSTEM

MAIN PUMP

Type	Variable displacement tandem axis piston pumps
Max. flow	2 x 126.8 l/min
Sub-pump for pilot circuit	Gear pump

Cross-sensing and fuel saving pump system

HYDRAULIC MOTORS

Travel	Two speed axial pistons motor with brake valve and parking brake
Swing	Axial piston motor with automatic brake

RELIEF VALVE SETTING

Implement circuits	350 kgf/cm ² (4,980 psi)
Travel	350 kgf/cm ² (4,980 psi)
Power boost (boom, arm, bucket)	380 kgf/cm ² (5,400 psi)
Swing circuit	285 kgf/cm ² (4,054 psi)
Pilot circuit	40 kgf/cm ² (570 psi)
Service valve	Installed

HYDRAULIC CYLINDERS

No. of cylinder bore x stroke	Boom: ø 105 x 1,075 mm
	Arm: ø 115 x 1,138 mm
	Bucket: ø 100 x 850 mm

DRIVES & BRAKES

Drive method	Fully hydrostatic type
Drive motor	Axial piston motor, in-shoe design
Reduction system	Planetary reduction gear
Max. drawbar pull	12,000 kgf (26,455 lbf)
Max. travel speed (high / low)	5.6 km/hr (3.5 mph) / 3.3 km/hr (2.1 mph)
Gradeability	35° (70%)
Parking brake	Multi wet disc

CONTROL

Pilot pressure operated joysticks and pedals with detachable lever provide almost effortless and fatigueless operation.

Pilot control	Two joysticks with one safety lever (LH): Swing and arm (RH): Boom and bucket (ISO)
Traveling and steering	Two levers with pedals
Engine throttle	Electric, Dial type

SWING SYSTEM

Swing motor	Fixed displacement axial piston motor
Swing reduction	Planetary gear reduction
Swing bearing lubrication	Grease-bathed
Swing brake	Multi wet disc
Swing speed	11.6 rpm

COOLANT & LUBRICANT CAPACITY

	liter	US gal	UK gal
Re-filling			
Fuel tank	270	71.3	59.4
Engine coolant	27.5	7.3	6.0
Engine oil	12	3.2	2.6
Swing device	3.5	0.9	0.76
Final drive (each)	2.3	0.60	0.50
Hydraulic system (including tank)	210	55.5	46.2
Hydraulic tank	124	32.8	27.3
DEF / AdBlue®	19	5	4.2

UNDERCARRIAGE

The X-leg type center frame is integrally welded with reinforced box-section track frames. The undercarriage includes lubricated rollers, idlers, track adjusters with shock absorbing springs and sprockets and a track chain with double or triple grouser shoes.

Center frame	X - leg type
Track frame	Pentagonal box type
No. of shoes on each side	46 EA
No. of carrier roller on each side	1 EA
No. of track roller on each side	7 EA
No. of rail guard on each side	1 EA

OPERATING WEIGHT (APPROXIMATE)

Operating weight, including 4,600 mm (15' 1") boom; 2,500 mm (8' 2") arm; SAE heaped 0.58 m³ (0.76 yd³) bucket, lubricant, coolant, full fuel tank, full hydraulic tank and all standard equipments.

OPERATING WEIGHT

Shoes		Operating weight		Ground pressure
Type	Width mm (in)	kg (lb)		kgf / cm ² (psi)
Triple grouser	500 (20")	HX140L C	13,840 (30,510)	0.43 (6.07)
		HX140LD C	14,660 (32,320)	0.45 (6.43)
	600 (24")	HX140L C	14,050 (30,975)	0.36 (5.13)
		HX140LD C	14,870 (32,780)	0.38 (5.43)
	700 (28")	HX140L C	14,260 (31,440)	0.31 (4.47)
		HX140LD C	15,080 (33,245)	0.33 (4.72)
Double grouser	700 (28")	HX140HW C	16,950 (37,370)	0.32 (4.58)
		HX140HW C	16,715 (36,850)	0.36 (5.16)

BUCKET SELECTION GUIDE & DIGGING FORCE

BUCKETS

All buckets are welded with high-strength steel.

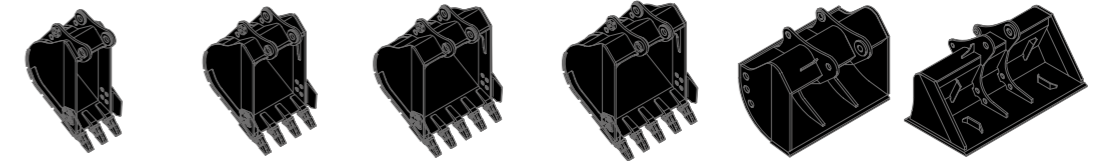

SAE heaped m ³ (yd ³)	0.23 (0.30)	0.40 (0.52)	0.52 (0.68)	0.65 (0.85)	◆ 0.45 (0.59)	◆ 0.55 (0.72)
		0.46 (0.60)	0.58 (0.76)	0.71 (0.93)		

Capacity m ³ (yd ³)	Width mm (in)	Weight kg (lb)	Recommendation mm (ft.in)							
			4,600 (15' 1") boom				4,100 (13' 5") boom			
			1,900 (6' 3") Arm	2,100 (6' 11") Arm	2,500 (8' 2") Arm	3,000 (9' 10") Arm	1,900 (6' 3") Arm	2,100 (6' 11") Arm		
0.23 (0.30)	CECE heaped	520 (20.5)	620 (24.4)	335 (740)	●	●	●	■	●	●
0.40 (0.52)	CECE heaped	750 (29.5)	850 (33.5)	410 (900)	●	●	●	■	●	●
0.46 (0.60)	CECE heaped	840 (33.1)	940 (37.0)	435 (960)	●	●	●	▲	●	●
0.52 (0.68)	CECE heaped	915 (36.0)	1,015 (40.0)	460 (1,010)	●	●	●	-	●	●
0.58 (0.76)	CECE heaped	1,000 (39.4)	1,100 (43.3)	480 (1,060)	●	●	■	-	●	●
0.65 (0.85)	CECE heaped	1,105 (43.5)	1,205 (47.4)	500 (1,100)	■	■	▲	-	●	■
0.71 (0.93)	CECE heaped	1,190 (46.9)	1,290 (50.8)	540 (1,190)	▲	▲	-	-	■	▲
◆ 0.45 (0.59)	Ditching bucket	1,520 (59.8)	-	410 (900)	●	●	■	-	●	●
◆ 0.55 (0.72)	Slope finishing bucket	1,800 (70.9)	-	585 (1,290)	■	■	▲	-	●	●

- ◆ Ditching bucket
- ◆ Slope finishing bucket

- : Applicable for materials with density of 2,000 kg / m³ (3,370 lb / yd³) or less
- : Applicable for materials with density of 1,600 kg / m³ (2,700 lb / yd³) or less
- ▲ : Applicable for materials with density of 1,100 kg / m³ (1,850 lb / yd³) or less

ATTACHMENT

Booms and arms are welded with a low-stress, full-box section design. 4.1 m (13' 5"); 4.6 m (15' 1") mono booms & 4.9 m (16' 9") hydraulic adjustable boom and 1.9 m (6' 3"); 2.1 m (6' 11"); 2.5 m (8' 2") & 3.0 m (9' 10") Arms are available.

DIGGING FORCE

Arm	Length	mm (ft.in)	1,900 (6' 3")	2,100 (6' 11")	2,500 (8' 2")	3,000 (9' 10")	Remarks:	
			Weight kg (lb)	560 (1,230)	580 (1,280)	610 (1,340)		670 (1,480)
Bucket digging force	SAE	kN	87.3 [94.8]	87.3 [94.8]	87.3 [94.8]	87.3 [94.8]	[]: Power Boost	
			kgf	8,900 [9,660]	8,900 [9,660]	8,900 [9,660]		8,900 [9,660]
		lbf	19,620 [21,300]	19,620 [21,300]	19,620 [21,300]	19,620 [21,300]		
			ISO	kN	102 [110.8]	102 [110.8]		102 [110.8]
		kgf	10,400 [11,290]	10,400 [11,290]	10,400 [11,290]	10,400 [11,290]		
			lbf	22,930 [24,890]	22,930 [24,890]	22,930 [24,890]		22,930 [24,890]
	Arm crowd force	SAE	kN	76.5 [83.1]	73.6 [79.9]	62.8 [68.2]		55.9 [60.7]
			kgf	7,800 [8,470]	7,500 [8,140]	6,400 [6,950]		5,700 [6,190]
			lbf	17,200 [18,670]	16,530 [17,950]	14,110 [15,320]		12,570 [13,640]
		ISO	kN	80.4 [87.3]	77.5 [84.1]	65.7 [71.4]		57.9 [62.8]
			kgf	8,200 [8,900]	7,900 [8,580]	6,700 [7,270]		5,900 [6,410]
			lbf	18,080 [19,630]	17,420 [18,910]	14,770 [16,040]		13,010 [14,120]

Note : Arm weight includes bucket cylinder, linkage, and pin

DIMENSIONS & WORKING RANGE

HX140L C DIMENSIONS

4.1 m (13' 5") & 4.6 m (15' 1") boom and 1.9 m (6' 3"); 2.1 m (6' 11"); 2.5 m (8' 2") & 3.0 m (9' 10") Arm.

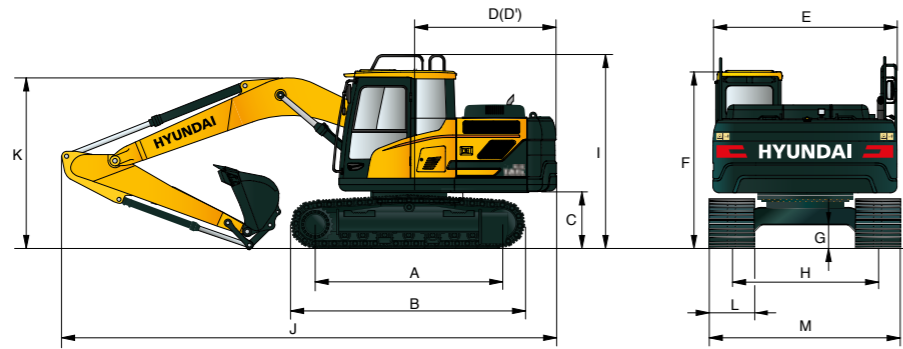

Unit : mm (ft-in)

A	Tumbler distance	3,000 (9' 10")
B	Overall length of crawler	3,708 (12' 2")
C	Ground clearance of counterweight	940 (3' 1")
D	Tail swing radius	2,330 (7' 7")
D'	Rear-end length	2,330 (7' 7")
E	Overall width of upperstructure	2,475 (8' 1")
F	Overall height of cab	2,860 (9' 5")
G	Min. ground clearance	440 (1' 5")
H	Track gauge	2,000 (6' 7")
I	Overall height of guardrail	3,100 (10' 2")

Boom length	4,600 (15' 1")				4,100 (13' 5")	
Arm length	1,900 (6' 3")	2,100 (6' 11")	2,500 (8' 2")	3,000 (9' 10")	1,900 (6' 3")	2,100 (6' 11")
J Overall length	7,820 (25' 7")	7,850 (25' 8")	7,820 (25' 7")	7,790 (25' 6")	7,320 (24' 0")	7,350 (24' 1")
K Overall height of boom	2,650 (8' 7")	2,760 (9' 0")	2,780 (9' 1")	3,110 (10' 2")	2,600 (8' 5")	2,790 (9' 2")
L Track shoe width	500 (20")		600 (24")		700 (28")	
M Overall width	2,500 (8' 2")		2,600 (8' 6")		2,700 (8' 10")	

HX140L C WORKING RANGE

Unit : mm (ft-in)

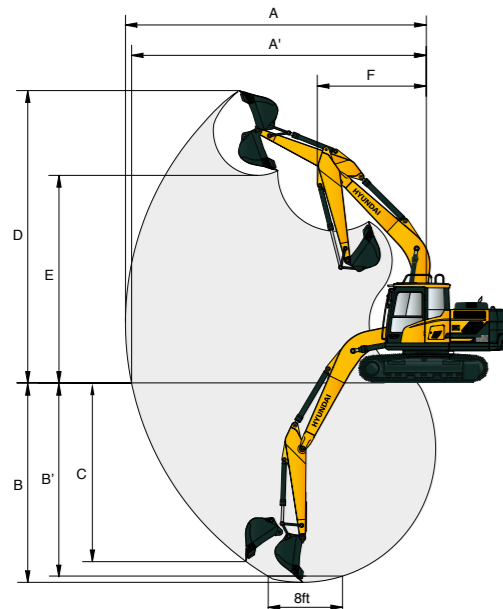

Boom length	4,600 (15' 1")				4,100 (13' 5")	
Arm length	1,900 (6' 3")	2,100 (6' 11")	2,500 (8' 2")	3,000 (9' 10")	1,900 (6' 3")	2,100 (6' 11")
A Max. digging reach	7,750 (25' 5")	7,920 (25' 11")	8,330 (27' 4")	8,790 (28' 10")	7,260 (23' 10")	7,420 (24' 4")
A' Max. digging reach on ground	7,600 (24' 11")	7,770 (25' 6")	8,180 (26' 10")	8,650 (28' 4")	7,090 (23' 3")	7,260 (23' 10")
B Max. digging depth	4,950 (16' 2")	5,150 (16' 10")	5,550 (18' 3")	6,050 (19' 10")	4,540 (14' 11")	4,740 (15' 7")
B' Max. digging depth (8' level)	4,680 (15' 4")	4,900 (16' 1")	5,340 (17' 6")	5,870 (19' 3")	4,280 (14' 1")	4,490 (14' 9")
C Max. vertical wall digging depth	4,650 (15' 3")	4,900 (16' 1")	5,330 (17' 6")	5,850 (19' 2")	4,240 (13' 11")	4,350 (14' 3")
D Max. digging height	8,100 (26' 7")	8,180 (26' 10")	8,500 (27' 11")	8,780 (28' 10")	7,700 (25' 3")	7,770 (25' 6")
E Max. dumping height	5,670 (18' 7")	5,750 (18' 10")	6,060 (19' 11")	6,330 (20' 9")	5,260 (17' 3")	5,340 (17' 6")
F Min. front swing radius	2,630 (8' 8")	2,670 (8' 9")	2,650 (8' 8")	2,680 (8' 10")	2,350 (7' 9")	2,460 (8' 1")

DIMENSIONS & WORKING RANGE

HX140LD C DIMENSIONS

4.1 m (13' 5") & 4.6 m (15' 1") boom and 1.9 m (6' 3"); 2.1 m (6' 11"); 2.5 m (8' 2") & 3.0 m (9' 10") Arm.

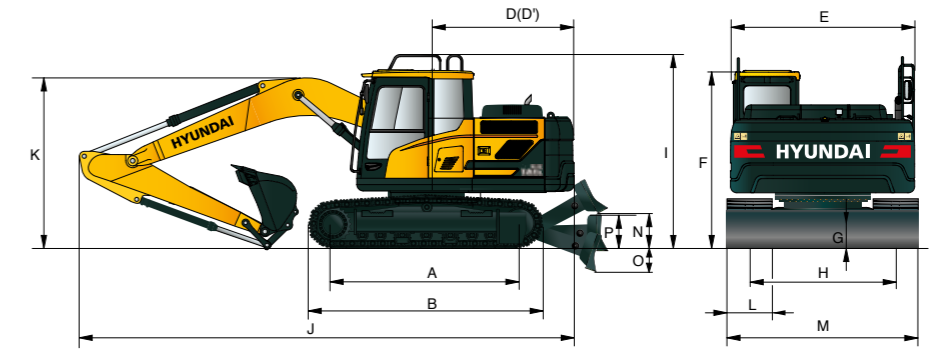

Unit : mm (ft-in)

A	Tumbler distance	3,000 (9' 10")
B	Overall length of crawler	3,708 (12' 2")
C	Ground clearance of counterweight	940 (3' 1")
D	Tail swing radius	2,330 (7' 7")
D'	Rear-end length	2,330 (7' 7")
E	Overall width of upperstructure	2,475 (8' 1")
F	Overall height of cab	2,960 (9' 9")
G	Min. ground clearance	440 (1' 5")
H	Track gauge	2,000 (6' 7")
I	Overall height of guardrail	3,180 (10' 5")
N	Ground clearance of blade up	560 (1' 10")
O	Depth of blade down	500 (1' 8")
P	Height of blade	575 (1' 11")

Boom length	4,600 (15' 1")				4,100 (13' 5")	
Arm length	1,900 (6' 3")	2,100 (6' 11")	2,500 (8' 2")	3,000 (9' 10")	1,900 (6' 3")	2,100 (6' 11")
J Overall length	8,130 (26' 7")	8,160 (26' 7")	8,130 (26' 7")	8,100 (26' 6")	7,630 (25' 0")	7,350 (24' 1")
K Overall height of boom	2,650 (8' 7")	2,760 (9' 0")	2,780 (9' 1")	3,110 (10' 2")	2,600 (8' 5")	2,790 (9' 2")
L Track shoe width	500 (20")		600 (24")		700 (28")	
M Overall width	2,500 (8' 2")		2,600 (8' 6")		2,700 (8' 10")	

HX140LD C WORKING RANGE

Unit : mm (ft-in)

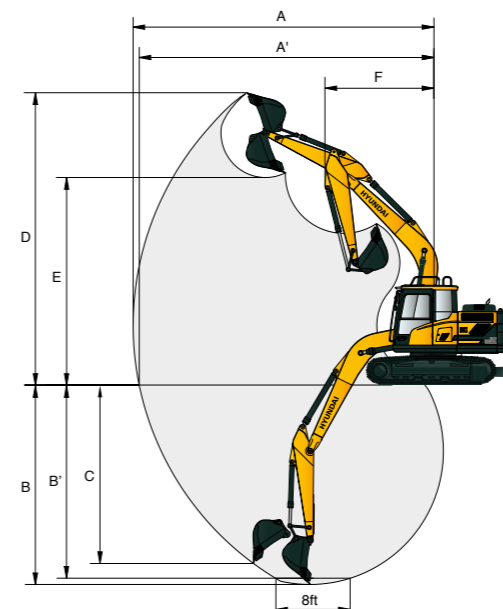

Boom length	4,600 (15' 1")				4,100 (13' 5")	
Arm length	1,900 (6' 3")	2,100 (6' 11")	2,500 (8' 2")	3,000 (9' 10")	1,900 (6' 3")	2,100 (6' 11")
A Max. digging reach	7,750 (25' 5")	7,920 (25' 11")	8,330 (27' 4")	8,790 (28' 10")	7,260 (23' 10")	7,420 (24' 4")
A' Max. digging reach on ground	7,600 (24' 11")	7,770 (25' 6")	8,180 (26' 10")	8,650 (28' 4")	7,090 (23' 3")	7,260 (23' 10")
B Max. digging depth	4,950 (16' 2")	5,150 (16' 10")	5,550 (18' 3")	6,050 (19' 10")	4,540 (14' 11")	4,740 (15' 7")
B' Max. digging depth (8' level)	4,680 (15' 4")	4,900 (16' 1")	5,340 (17' 6")	5,870 (19' 3")	4,280 (14' 1")	4,490 (14' 9")
C Max. vertical wall digging depth	4,650 (15' 3")	4,900 (16' 1")	5,330 (17' 6")	5,850 (19' 2")	4,240 (13' 11")	4,350 (14' 3")
D Max. digging height	8,100 (26' 7")	8,180 (26' 10")	8,500 (27' 11")	8,780 (28' 10")	7,700 (25' 3")	7,770 (25' 6")
E Max. dumping height	5,670 (18' 7")	5,750 (18' 10")	6,060 (19' 11")	6,330 (20' 9")	5,260 (17' 3")	5,340 (17' 6")
F Min. front swing radius	2,630 (8' 8")	2,670 (8' 9")	2,650 (8' 8")	2,680 (8' 10")	2,350 (7' 9")	2,460 (8' 1")

DIMENSIONS & WORKING RANGE

HX140HW C DIMENSIONS

4.1 m (13' 5") & 4.6 m (15' 1") boom and 1.9 m (6' 3"); 2.1 m (6' 11"); 2.5 m (8' 2") & 3.0 m (9' 10") Arm.

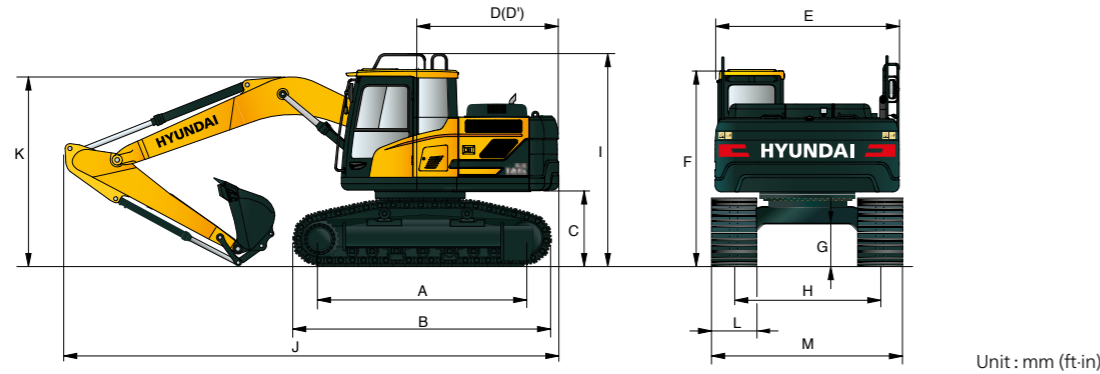

Unit : mm (ft-in)

A	Tumbler distance	3,000 (9' 10")
B	Overall length of crawler	3,740 (12' 3")
C	Ground clearance of counterweight	1,200 (3' 11")
D	Tail swing radius	2,330 (7' 7")
D'	Rear-end length	2,330 (7' 7")
E	Overall width of upperstructure	2,475 (8' 1")
F	Overall height of cab	3,220 (10' 7")
G	Min. ground clearance	600 (1' 12")
H	Track gauge	2,040 (6' 8")
I	Overall height of guardrail	3,100 (10' 2")

Boom length	4,600 (15' 1")				4,100 (13' 5")		
Arm length	1,900 (6' 3")	2,100 (6' 11")	2,500 (8' 2")	3,000 (9' 10")	1,900 (6' 3")	2,100 (6' 11")	
J	Overall length	7,820 (25' 7")	7,850 (25' 8")	7,820 (25' 7")	7,790 (25' 6")	7,320 (24' 0")	7,350 (24' 1")
K	Overall height of boom	2,650 (8' 7")	2,760 (9' 0")	2,780 (9' 1")	3,110 (10' 2")	2,600 (8' 5")	2,790 (9' 2")
L	Track shoe width	700 (28")	800 (32")			900 (36")	
M	Overall width	2,740 (8' 11")	2,840 (9' 3")			3,000 (9' 10")	

HX140HW C WORKING RANGE

Unit : mm (ft-in)

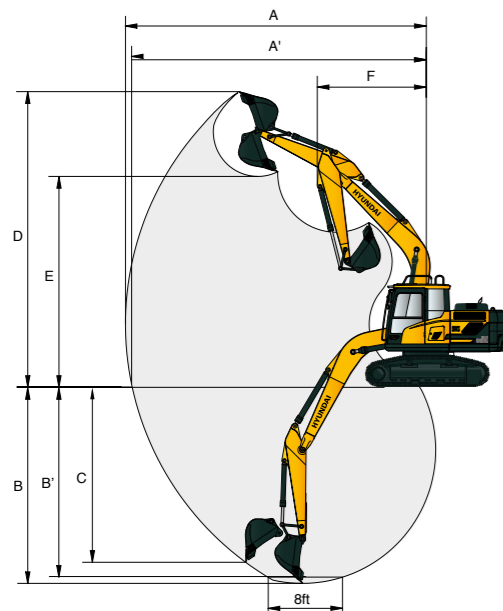

Boom length	4,600 (15' 1")				4,100 (13' 5")		
Arm length	1,900 (6' 3")	2,100 (6' 11")	2,500 (8' 2")	3,000 (9' 10")	1,900 (6' 3")	2,100 (6' 11")	
A	Max. digging reach	7,750 (25' 5")	7,920 (25' 11")	8,330 (27' 4")	8,790 (28' 10")	7,260 (23' 10")	7,420 (24' 4")
A'	Max. digging reach on ground	7,540 (24' 9")	7,710 (25' 4")	8,110 (26' 7")	8,580 (28' 2")	7,020 (23' 10")	7,200 (23' 7")
B	Max. digging depth	4,690 (15' 5")	4,890 (16' 1")	5,290 (17' 4")	5,790 (19' 0")	4,280 (14' 1")	4,480 (14' 8")
B'	Max. digging depth (8' level)	4,420 (14' 6")	4,640 (15' 3")	5,080 (16' 8")	5,610 (18' 5")	4,020 (13' 2")	4,230 (13' 11")
C	Max. vertical wall digging depth	4,390 (14' 5")	4,640 (15' 3")	5,070 (16' 8")	5,590 (18' 4")	3,980 (13' 1")	4,090 (13' 5")
D	Max. digging height	8,360 (27' 5")	8,440 (27' 8")	8,760 (28' 9")	9,040 (29' 7")	7,960 (26' 1")	8,030 (26' 4")
E	Max. dumping height	5,930 (19' 5")	6,010 (19' 8")	6,320 (20' 9")	6,590 (21' 7")	5,520 (18' 1")	5,600 (18' 4")
F	Min. front swing radius	2,630 (8' 8")	2,670 (8' 9")	2,650 (8' 8")	2,680 (8' 10")	2,350 (7' 9")	2,460 (8' 1")

DIMENSIONS & WORKING RANGE

HX140L C 2-PIECE BOOM DIMENSIONS

4.9 m (16' 1") 2-piece boom and 1.9 m (6' 3"); 2.1 m (6' 11"); 2.5 m (8' 2") & 3.0 m (9' 10") Arm.

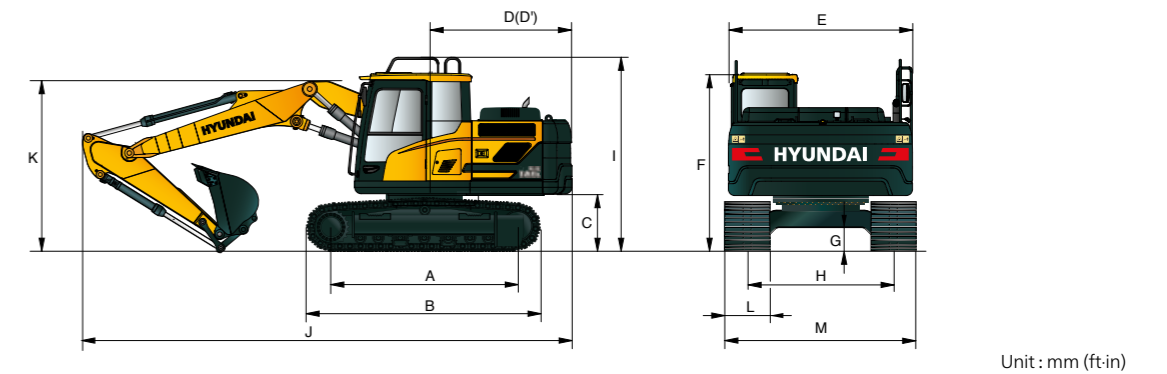

Unit : mm (ft-in)

A	Tumbler distance	3,000 (9' 10")
B	Overall length of crawler	3,750 (12' 4")
C	Ground clearance of counterweight	940 (3' 1")
D	Tail swing radius	2,330 (7' 7")
D'	Rear-end length	2,330 (7' 7")
E	Overall width of upperstructure	2,500 (8' 2")
F	Overall height of cab	2,870 (9' 4")
G	Min. ground clearance	440 (1' 5")
H	Track gauge	2,000 (6' 7")
I	Overall height of guardrail	3,100 (10' 2")

Boom length	4,900 (16' 1") 2-Piece boom			
Arm length	1,900 (6' 3")	2,100 (6' 11")	2,500 (8' 2")	
J	Overall length	8,160 (26' 8")	8,170 (26' 8")	8,150 (26' 8")
K	Overall height of boom	2,830 (9' 3")	2,940 (9' 6")	2,960 (9' 7")
L	Track shoe width	500 (20")	600 (24")	700 (28")
M	Overall width	2,500 (8' 2")	2,600 (8' 6")	2,700 (8' 10")

HX140L C 2-PIECE BOOM WORKING RANGE

Unit : mm (ft-in)

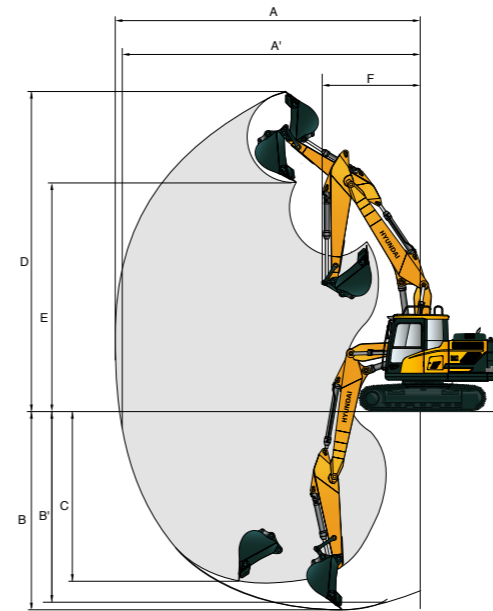











Boom length	4,900 (16' 1") 2-Piece boom			
Arm length	1,900 (6' 3")	2,100 (6' 11")	2,500 (8' 2")	
A	Max. digging reach	8,140 (26' 8")	8,320 (27' 4")	8,720 (28' 7")
A'	Max. digging reach on ground	8,000 (26' 3")	8,180 (26' 10")	8,590 (28' 2")
B	Max. digging depth	5,110 (16' 9")	5,310 (17' 5")	5,710 (18' 9")
B'	Max. digging depth (8' level)	5,000 (16' 5")	5,190 (17' 0")	5,610 (18' 5")
C	Max. vertical wall digging depth	4,490 (14' 9")	4,660 (15' 3")	5,120 (16' 10")
D	Max. digging height	8,810 (28' 11")	8,890 (29' 2")	9,270 (30' 5")
E	Max. dumping height	6,330 (20' 9")	6,410 (21' 0")	6,780 (22' 3")
F	Min. front swing radius	2,670 (8' 9")	2,830 (9' 3")	2,690 (8' 10")

LIFTING CAPACITY











 Rating over-front  Rating over-side or 360 degrees

HX140L C











Boom : 4.1 m (13' 5") / Arm : 1.9 m (6' 3") / Shoe : 600 mm (24") triple grouser / Counter weight : 2,000 kg / Dozer none

Load point height m (ft)	Load radius								At max. reach		
	1.5 m (4.9 ft)		3.0 m (9.8 ft)		4.5 m (14.8 ft)		6.0 m (19.7 ft)		Capacity	Reach	
											m (ft)
6.0 m (19.7 ft)	kg								*3,500	*3,500	4.01
	lb								*7,720	*7,720	(13.2)
4.5 m (14.8 ft)	kg			*4,620	4,100				*3,070	*3,070	5.24
	lb			*10,190	9,040				*6,770	*6,770	(17.2)
3.0 m (9.8 ft)	kg		*7,190	*7,190	*5,320	3,960			*3,020	2,670	5.83
	lb		*15,850	*15,850	*11,730	8,730			*6,660	5,890	(19.1)
1.5 m (4.9 ft)	kg		*9,910	6,870	5,790	3,780	*3,230	2,510	*3,220	2,500	6.00
	lb		*21,850	15,150	12,760	8,330	*7,120	5,530	*7,100	5,510	(19.7)
Ground Line	kg		*10,670	6,660	5,650	3,660			*3,720	2,600	5.78
	lb		*23,520	14,680	12,460	8,070			*8,200	5,730	(19.0)
-1.5 m (-4.9 ft)	kg	*8,110	*8,110	*9,920	6,680	5,640	3,640		4,670	3,080	5.11
	lb	*17,880	*17,880	*21,870	14,730	12,430	8,020		10,300	6,790	(16.7)
-3.0 m (-9.8 ft)	kg			*7,310	6,860				*5,520	4,900	3.75
	lb			*16,120	15,120				*12,170	10,800	(12.3)

Boom : 4.1 m (13' 5") / Arm : 1.9 m (6' 3") / Shoe : 600 mm (24") triple grouser / Counter weight : 2,000 kg / Dozer down

Load point height m (ft)	Load radius								At max. reach		
	1.5 m (4.9 ft)		3.0 m (9.8 ft)		4.5 m (14.8 ft)		6.0 m (19.7 ft)		Capacity	Reach	
											m (ft)
6.0 m (19.7 ft)	kg								*3,500	*3,500	4.01
	lb								*7,720	*7,720	(13.2)
4.5 m (14.8 ft)	kg			*4,620	*4,620				*3,070	*3,070	5.24
	lb			*10,190	*10,190				*6,770	*6,770	(17.2)
3.0 m (9.8 ft)	kg		*7,190	*7,190	*5,320	4,510			*3,020	*3,020	5.83
	lb		*15,850	*15,850	*11,730	9,940			*6,660	*6,660	(19.1)
1.5 m (4.9 ft)	kg		*9,910	7,970	*6,300	4,320	*3,230	2,860	*3,220	2,860	6.00
	lb		*21,850	17,570	*13,890	9,520	*7,120	6,310	*7,100	6,310	(19.7)
Ground Line	kg		*10,670	7,760	*6,870	4,200			*3,720	2,970	5.78
	lb		*23,520	17,110	*15,150	9,260			*8,200	6,550	(19.0)
-1.5 m (-4.9 ft)	kg	*8,110	*8,110	*9,920	7,780	*6,560	4,180		*4,950	3,530	5.11
	lb	*17,880	*17,880	*21,870	17,150	*14,460	9,220		*10,910	7,780	(16.7)
-3.0 m (-9.8 ft)	kg			*7,310	*7,310				*5,520	*5,520	3.75
	lb			*16,120	*16,120				*12,170	*12,170	(12.3)

Boom : 4.1 m (13' 5") / Arm : 1.9 m (6' 3") / Shoe : 600 mm (24") triple grouser / Counter weight : 2,000 kg / Dozer up

Load point height m (ft)	Load radius								At max. reach		
	1.5 m (4.9 ft)		3.0 m (9.8 ft)		4.5 m (14.8 ft)		6.0 m (19.7 ft)		Capacity	Reach	
											m (ft)
6.0 m (19.7 ft)	kg								*3,500	*3,500	4.01
	lb								*7,720	*7,720	(13.2)
4.5 m (14.8 ft)	kg			*4,620	4,310				*3,070	*3,070	5.24
	lb			*10,190	9,500				*6,770	*6,770	(17.2)
3.0 m (9.8 ft)	kg		*7,190	*7,190	*5,320	4,170			*3,020	2,810	5.83
	lb		*15,850	*15,850	*11,730	9,190			*6,660	6,190	(19.1)
1.5 m (4.9 ft)	kg		*9,910	7,230	5,790	3,980	*3,230	2,650	*3,220	2,650	6.00
	lb		*21,850	15,940	12,760	8,770	*7,120	5,840	*7,100	5,840	(19.7)
Ground Line	kg		*10,670	7,030	5,650	3,860			*3,720	2,750	5.78
	lb		*23,520	15,500	12,460	8,510			*8,200	6,060	(19.0)
-1.5 m (-4.9 ft)	kg	*8,110	*8,110	*9,920	7,040	5,630	3,850		4,670	3,260	5.11
	lb	*17,880	*17,880	*21,870	15,520	12,410	8,490		10,300	7,190	(16.7)
-3.0 m (-9.8 ft)	kg			*7,310	7,230				*5,520	5,160	3.75
	lb			*16,120	15,940				*12,170	11,380	(12.3)

1. Lifting capacity are based on ISO 10567.
2. Lifting capacity of the HX series does not exceed 75% of tipping load with the machine on firm, level ground or 87% of full hydraulic capacity.











3. The Lift-point is bucket pivot mounting pin on the arm (without bucket mass).
4. (*) indicates load limited by hydraulic capacity.

LIFTING CAPACITY











 Rating over-front  Rating over-side or 360 degrees

HX140L C











Boom : 4.1 m (13' 5") / Arm : 2.1 m (6' 11") / Shoe : 600 mm (24") triple grouser / Counter weight : 2,000 kg / Dozer none

Load point height m (ft)	Load radius								At max. reach		
	1.5 m (4.9 ft)		3.0 m (9.8 ft)		4.5 m (14.8 ft)		6.0 m (19.7 ft)		Capacity	Reach	
											m (ft)
6.0 m (19.7 ft)	kg								*3,360	*3,360	4.26
	lb								*7,410	*7,410	(14.0)
4.5 m (14.8 ft)	kg					*4,370	4,120		*2,990	*2,990	5.43
	lb					*9,630	9,080		*6,590	*6,590	(17.8)
3.0 m (9.8 ft)	kg			*6,740	*6,740	*5,110	3,970	*3,030	2,550		6.01
	lb			*14,860	*14,860	*11,270	8,750	*6,680	5,620		(19.7)
1.5 m (4.9 ft)	kg			*9,580	6,890	5,790	3,780	3,720	2,500		6.17
	lb			*21,120	15,190	12,760	8,330	8,200	5,510		(20.2)
Ground Line	kg			*10,620	6,640	5,640	3,640				5.95
	lb			*23,410	14,640	12,430	8,020				(19.5)
-1.5 m (-4.9 ft)	kg	*7,660	*7,660	*10,090	6,630	5,600	3,610		4,390	2,900	5.30
	lb	*16,890	*16,890	*22,240	14,620	12,350	7,960		9,680	6,390	(17.4)
-3.0 m (-9.8 ft)	kg			*7,830	6,790				*5,510	4,370	4.02
	lb			*17,260	14,970				*12,150	9,630	(13.2)

Boom : 4.1 m (13' 5") / Arm : 2.1 m (6' 11") / Shoe : 600 mm (24") triple grouser / Counter weight : 2,000 kg / Dozer down

Load point height m (ft)	Load radius								At max. reach		
	1.5 m (4.9 ft)		3.0 m (9.8 ft)		4.5 m (14.8 ft)		6.0 m (19.7 ft)		Capacity	Reach	
											m (ft)
6.0 m (19.7 ft)	kg								*3,360	*3,360	4.26
	lb								*7,410	*7,410	(14.0)
4.5 m (14.8 ft)	kg					*4,370	*4,370		*2,990	*2,990	5.43
	lb					*9,630	*9,630		*6,590	*6,590	(17.8)
3.0 m (9.8 ft)	kg			*6,740	*6,740	*5,110	4,520	*3,030	2,910		6.01
	lb			*14,860	*14,860	*11,270	9,960	*6,680	6,420		(19.7)
1.5 m (4.9 ft)	kg			*9,580	8,000	*6,140	4,320	*4,480	2,850		6.17
	lb			*21,120	17,640	*13,540	9,520	*9,880	6,280		(20.2)
Ground Line	kg			*10,620	7,730	*6,800	4,180				5.95
	lb			*23,410	17,040	*14,990	9,220				(19.5)
-1.5 m (-4.9 ft)	kg	*7,660	*7,660	*10,090	7,720	*6,650	4,150		*4,800	3,320	5.30
	lb	*16,890	*16,890	*22,240	17,020	*14,660	9,150		*10,580	7,320	(17.4)
-3.0 m (-9.8 ft)	kg			*7,830	*7,830				*5,510	5,020	4.02
	lb			*17,260	*17,260				*12,150	11,070	(13.2)

Boom : 4.1 m (13' 5") / Arm : 2.1 m (6' 11") / Shoe : 600 mm (24") triple grouser / Counter weight : 2,000 kg / Dozer up

Load point height m (ft)	Load radius								At max. reach	
	1.5 m (4.9 ft)		3.0 m (9.8 ft)		4.5 m (14.8 ft)		6.0 m (19.7 ft)		Capacity	Reach
										

LIFTING CAPACITY

Rating over-front Rating over-side or 360 degrees

HX140L C

Boom : 4.1 m (13' 5") / Arm : 2.5 m (8' 2") / Shoe : 600 mm (24") triple grouser / Counter weight : 2,000 kg / Dozer none

Load point height m (ft)	Load radius								At max. reach		
	1.5 m (4.9 ft)		3.0 m (9.8 ft)		4.5 m (14.8 ft)		6.0 m (19.7 ft)		Capacity	Reach	
6.0 m (19.7 ft)	kg			*3,210	*3,210			*2,210	*2,210	4.85	
	lb			*7,080	*7,080			*4,870	*4,870	(15.9)	
4.5 m (14.8 ft)	kg			*3,890	*3,890			*1,980	*1,980	5.90	
	lb			*8,580	*8,580			*4,370	*4,370	(19.3)	
3.0 m (9.8 ft)	kg		*5,830	*5,830	*4,690	4,000	*3,610	2,570	*1,950	*1,950	6.43
	lb		*12,850	*12,850	*10,340	8,820	*7,960	5,670	*4,300	*4,300	(21.1)
1.5 m (4.9 ft)	kg		*8,870	6,980	*5,800	3,790	3,710	2,490	*2,050	*2,050	6.58
	lb		*19,550	15,390	*12,790	8,360	8,180	5,490	*4,520	*4,520	(21.6)
Ground Line	kg		*10,430	6,620	5,620	3,620	3,640	2,420	*2,310	2,220	6.38
	lb		*22,990	14,590	12,390	7,980	8,020	5,340	*5,090	4,890	(20.9)
-1.5 m (-4.9 ft)	kg	*6,570	*6,570	*10,330	6,550	5,550	3,560		*2,890	2,540	5.78
	lb	*14,480	*14,480	*22,770	14,440	12,240	7,850		*6,370	5,600	(19.0)
-3.0 m (-9.8 ft)	kg	*11,700	*11,700	*8,660	6,670	*5,420	3,640		*4,570	3,510	4.63
	lb	*25,790	*25,790	*19,090	14,700	*11,950	8,020		*10,080	7,740	(15.2)

Boom : 4.1 m (13' 5") / Arm : 2.5 m (8' 2") / Shoe : 600 mm (24") triple grouser / Counter weight : 2,000 kg / Dozer down

Load point height m (ft)	Load radius								At max. reach		
	1.5 m (4.9 ft)		3.0 m (9.8 ft)		4.5 m (14.8 ft)		6.0 m (19.7 ft)		Capacity	Reach	
6.0 m (19.7 ft)	kg			*3,210	*3,210			*2,210	*2,210	4.85	
	lb			*7,080	*7,080			*4,870	*4,870	(15.9)	
4.5 m (14.8 ft)	kg			*3,890	*3,890			*1,980	*1,980	5.90	
	lb			*8,580	*8,580			*4,370	*4,370	(19.3)	
3.0 m (9.8 ft)	kg		*5,830	*5,830	*4,690	4,550	*3,610	2,920	*1,950	*1,950	6.43
	lb		*12,850	*12,850	*10,340	10,030	*7,960	6,440	*4,300	*4,300	(21.1)
1.5 m (4.9 ft)	kg		*8,870	8,090	*5,800	4,330	*4,650	2,840	*2,050	*2,050	6.58
	lb		*19,550	17,840	*12,790	9,550	*10,250	6,260	*4,520	*4,520	(21.6)
Ground Line	kg		*10,430	7,720	*6,630	4,160	*4,830	2,770	*2,310	*2,310	6.38
	lb		*22,990	17,020	*14,620	9,170	*10,650	6,110	*5,090	*5,090	(20.9)
-1.5 m (-4.9 ft)	kg	*6,570	*6,570	*10,330	7,650	*6,740	4,100		*2,890	*2,890	5.78
	lb	*14,480	*14,480	*22,770	16,870	*14,860	9,040		*6,370	*6,370	(19.0)
-3.0 m (-9.8 ft)	kg	*11,700	*11,700	*8,660	7,770	*5,420	4,180		*4,570	4,030	4.63
	lb	*25,790	*25,790	*19,090	17,130	*11,950	9,220		*10,080	8,880	(15.2)

Boom : 4.1 m (13' 5") / Arm : 2.5 m (8' 2") / Shoe : 600 mm (24") triple grouser / Counter weight : 2,000 kg / Dozer up

Load point height m (ft)	Load radius								At max. reach		
	1.5 m (4.9 ft)		3.0 m (9.8 ft)		4.5 m (14.8 ft)		6.0 m (19.7 ft)		Capacity	Reach	
6.0 m (19.7 ft)	kg			*3,210	*3,210			*2,210	*2,210	4.85	
	lb			*7,080	*7,080			*4,870	*4,870	(15.9)	
4.5 m (14.8 ft)	kg			*3,890	*3,890			*1,980	*1,980	5.90	
	lb			*8,580	*8,580			*4,370	*4,370	(19.3)	
3.0 m (9.8 ft)	kg		*5,830	*5,830	*4,690	4,210	*3,610	2,710	*1,950	*1,950	6.43
	lb		*12,850	*12,850	*10,340	9,280	*7,960	5,970	*4,300	*4,300	(21.1)
1.5 m (4.9 ft)	kg		*8,870	7,340	*5,800	3,990	3,710	2,630	*2,050	*2,050	6.58
	lb		*19,550	16,180	*12,790	8,800	8,180	5,800	*4,520	*4,520	(21.6)
Ground Line	kg		*10,430	6,980	5,620	3,830	3,640	2,560	*2,310	*2,310	6.38
	lb		*22,990	15,390	12,390	8,440	8,020	5,640	*5,090	*5,090	(20.9)
-1.5 m (-4.9 ft)	kg	*6,570	*6,570	*10,330	6,910	5,550	3,770		*2,890	2,690	5.78
	lb	*14,480	*14,480	*22,770	15,230	12,240	8,310		*6,370	5,930	(19.0)
-3.0 m (-9.8 ft)	kg	*11,700	*11,700	*8,660	7,030	*5,420	3,850		*4,570	3,710	4.63
	lb	*25,790	*25,790	*19,090	15,500	*11,950	8,490		*10,080	8,180	(15.2)

1. Lifting capacity are based on ISO 10567.
2. Lifting capacity of the HX series does not exceed 75% of tipping load with the machine on firm, level ground or 87% of full hydraulic capacity.

3. The Lift-point is bucket pivot mounting pin on the arm (without bucket mass).
4. (*) indicates load limited by hydraulic capacity.

LIFTING CAPACITY

Rating over-front Rating over-side or 360 degrees

HX140L C

Boom : 4.6 m (15' 1") / Arm : 1.9 m (6' 3") / Shoe : 600 mm (24") triple grouser / Counter weight : 2,000 kg / Dozer none

Load point height m (ft)	Load radius								At max. reach			
	1.5 m (4.9 ft)		3.0 m (9.8 ft)		4.5 m (14.8 ft)		6.0 m (19.7 ft)		Capacity	Reach		
6.0 m (19.7 ft)	kg					*4,200	4,120		*3,650	*3,650	4.73	
	lb					*9,260	9,080		*8,050	*8,050	(15.5)	
4.5 m (14.8 ft)	kg					*4,330	4,070		*3,340	2,720	5.80	
	lb					*9,550	8,970		*7,360	6,000	(19.0)	
3.0 m (9.8 ft)	kg					*5,220	3,880	3,760	2,530	*3,330	2,320	6.35
	lb					*11,510	8,550	8,290	5,580	*7,340	5,110	(20.8)
1.5 m (4.9 ft)	kg					5,670	3,680	3,680	2,460	3,270	2,190	6.50
	lb					12,500	8,110	8,110	5,420	7,210	4,830	(21.3)
Ground Line	kg					*5,750	*5,750	5,540	3,550	3,620	2,400	6.29
	lb					*12,680	*12,680	12,210	7,830	7,980	5,290	(20.6)
-1.5 m (-4.9 ft)	kg	*5,700	*5,700	*9,710	6,520	5,520	3,540			3,920	2,590	5.68
	lb	*12,570	*12,570	*21,410	14,370	12,170	7,800			8,640	5,710	(18.6)
-3.0 m (-9.8 ft)	kg					*7,880	6,670	*5,100	3,650			4.51
	lb					*17,370	14,700	*11,240	8,050			(14.8)

Boom : 4.6 m (15' 1") / Arm : 1.9 m (6' 3") / Shoe : 600 mm (24") triple grouser / Counter weight : 2,000 kg / Dozer down

Load point height m (ft)	Load radius								At max. reach			
	1.5 m (4.9 ft)		3.0 m (9.8 ft)		4.5 m (14.8 ft)		6.0 m (19.7 ft)		Capacity	Reach		
6.0 m (19.7 ft)	kg					*4,200	*4,200		*3,650	*3,650	4.73	
	lb					*9,260	*9,260		*8,050	*8,050	(15.5)	
4.5 m (14.8 ft)	kg					*4,330	*4,330		*3,340	3,090	5.80	
	lb					*9,550	*9,550		*7,360	6,810	(19.0)	
3.0 m (9.8 ft)	kg					*5,220	4,420	*4,420	2,890	*3,330	2,650	6.35
	lb					*11,510	9,740	*9,740	6,370	*7,340	5,840	(20.8)
1.5 m (4.9 ft)	kg					*6,220	4,210	*4,790	2,810	*3,540	2,510	6.50
	lb					*13,710	9,280	*10,560	6,190	*7,800	5,530	(21.3)
Ground Line	kg					*5,750	*5,750	*6,760	4,090	*4,990	2,750	6.29
	lb					*12,680	*12,680	*14,900	9,020	*11,000	6,060	(20.6)
-1.5 m (-4.9 ft)	kg	*5,700	*5,700	*9,710	7,610	*6,600	4,070			*4,960	2,970	5.68
	lb	*12,570	*12,570	*21,410	16,780	*14,550	8,970			*10,930	6,550	(18.6)
-3.0 m (-9.8 ft)	kg					*7,880	7,770	*5,100	4,190			4.51
	lb					*17,370	17,130	*11,240	9,240			(14.8)

Boom : 4.6 m (15' 1") / Arm : 1.9 m (6' 3") / Shoe : 600 mm (24") triple grouser / Counter weight : 2,000 kg / Dozer up











Load point height m (ft)	Load radius								At max. reach			
	1.5 m (4.9 ft)		3.0 m (9.8 ft)		4.5 m (14.8 ft)		6.0 m (19.7 ft)		Capacity	Reach		
6.0 m (19.7 ft)	kg					*4,200	*4,200		*3,650	*3,650	4.73	
	lb					*9,260	*9,260		*8,050	*8,050	(15.5)	
4.5 m (14.8 ft)	kg					*4,330	4,280		*3,340	2,870	5.80	
	lb					*9,550	9,440		*7,360	6,330	(19.0)	
3.0 m (9.8 ft)	kg					*5,220	4,090	3,760	2,680	*3,330	2,450	6.35
	lb					*11,510	9,020	8,290	5,910	*7,340	5,400	(20.8)
1.5 m (4.9 ft)	kg					5,670	3,880	3,670	2,600	3,260	2,320	6.50
	lb					12,500						

LIFTING CAPACITY











 Rating over-front  Rating over-side or 360 degrees

HX140L C











Boom : 4.6 m (15' 1") / Arm : 1.9 m (6' 3") / Shoe : 600 mm (24") triple grouser / Counter weight : 2,300 kg / Dozer none

Load point height m (ft)	Load radius								At max. reach		
	1.5 m (4.9 ft)		3.0 m (9.8 ft)		4.5 m (14.8 ft)		6.0 m (19.7 ft)		Capacity	Reach	
											m (ft)
6.0 m (19.7 ft)	kg				*4,200	*4,200			*3,650	*3,650	4.73
	lb				*9,260	*9,260			*8,050	*8,050	(15.5)
4.5 m (14.8 ft)	kg				*4,330	4,280			*3,340	2,870	5.80
	lb				*9,550	9,440			*7,360	6,330	(19.0)
3.0 m (9.8 ft)	kg				*5,220	4,090	3,940	2,680	*3,330	2,460	6.35
	lb				*11,510	9,020	8,690	5,910	*7,340	5,420	(20.8)
1.5 m (4.9 ft)	kg				5,950	3,890	3,860	2,600	3,430	2,320	6.50
	lb				13,120	8,580	8,510	5,730	7,560	5,110	(21.3)
Ground Line	kg				*5,750	*5,750	5,810	3,770	3,550	2,390	6.29
	lb				*12,680	*12,680	12,810	8,310	7,830	5,270	(20.6)
-1.5 m (-4.9 ft)	kg	*5,700	*5,700	*9,710	6,890	5,790	3,750		4,110	2,750	5.68
	lb	*12,570	*12,570	*21,410	15,190	12,760	8,270		9,060	6,060	(18.6)
-3.0 m (-9.8 ft)	kg			*7,880	7,050	*5,100	3,860		*5,080	3,850	4.51
	lb			*17,370	15,540	*11,240	8,510		*11,200	8,490	(14.8)

Boom : 4.6 m (15' 1") / Arm : 1.9 m (6' 3") / Shoe : 600 mm (24") triple grouser / Counter weight : 2,300 kg / Dozer down

Load point height m (ft)	Load radius								At max. reach		
	1.5 m (4.9 ft)		3.0 m (9.8 ft)		4.5 m (14.8 ft)		6.0 m (19.7 ft)		Capacity	Reach	
											m (ft)
6.0 m (19.7 ft)	kg				*4,200	*4,200			*3,650	*3,650	4.73
	lb				*9,260	*9,260			*8,050	*8,050	(15.5)
4.5 m (14.8 ft)	kg				*4,330	*4,330			*3,340	3,250	5.80
	lb				*9,550	*9,550			*7,360	7,170	(19.0)
3.0 m (9.8 ft)	kg				*5,220	4,650	*4,420	3,040	*3,330	2,790	6.35
	lb				*11,510	10,250	*9,740	6,700	*7,340	6,150	(20.8)
1.5 m (4.9 ft)	kg				*6,220	4,430	*4,790	2,960	*3,540	2,640	6.50
	lb				*13,710	9,770	*10,560	6,530	*7,800	5,820	(21.3)
Ground Line	kg				*5,750	*5,750	*6,760	4,310	*4,050	2,730	6.29
	lb				*12,680	*12,680	*14,900	9,500	*8,930	6,020	(20.6)
-1.5 m (-4.9 ft)	kg	*5,700	*5,700	*9,710	8,010	*6,600	4,290		*4,960	3,130	5.68
	lb	*12,570	*12,570	*21,410	17,660	*14,550	9,460		*10,930	6,900	(18.6)
-3.0 m (-9.8 ft)	kg			*7,880	*7,880	*5,100	4,410		*5,080	4,400	4.51
	lb			*17,370	*17,370	*11,240	9,720		*11,200	9,700	(14.8)



Boom : 4.6 m (15' 1") / Arm : 1.9 m (6' 3") / Shoe : 600 mm (24") triple grouser / Counter weight : 2,300 kg / Dozer up

Load point height m (ft)	Load radius								At max. reach		
	1.5 m (4.9 ft)		3.0 m (9.8 ft)		4.5 m (14.8 ft)		6.0 m (19.7 ft)		Capacity	Reach	
											m (ft)
6.0 m (19.7 ft)	kg				*4,200	*4,200			*3,650	*3,650	4.73
	lb				*9,260	*9,260			*8,050	*8,050	(15.5)
4.5 m (14.8 ft)	kg				*4,330	*4,330			*3,340	3,020	5.80
	lb				*9,550	*9,550			*7,360	6,660	(19.0)
3.0 m (9.8 ft)	kg				*5,220	4,300	3,940	2,820	*3,330	2,590	6.35
	lb				*11,510	9,480	8,690	6,220	*7,340	5,710	(20.8)
1.5 m (4.9 ft)	kg				5,940	4,090	3,850	2,740	3,430	2,450	6.50
	lb				13,100	9,020	8,490	6,040	7,560	5,400	(21.3)
Ground Line	kg				*5,750	*5,750	5,800	3,970	3,550	2,530	6.29
	lb				*12,680	*12,680	12,790	8,750	7,830	5,580	(20.6)
-1.5 m (-4.9 ft)	kg	*5,700	*5,700	*9,710	7,260	5,780	3,950		4,110	2,900	5.68
	lb	*12,570	*12,570	*21,410	16,010	12,740	8,710		9,060	6,390	(18.6)
-3.0 m (-9.8 ft)	kg			*7,880	7,410	*5,100	4,070		*5,080	4,050	4.51
	lb			*17,370	16,340	*11,240	8,970		*11,200	8,930	(14.8)

1. Lifting capacity are based on ISO 10567.
2. Lifting capacity of the HX series does not exceed 75% of tipping load with the machine on firm, level ground or 87% of full hydraulic capacity.











3. The Lift-point is bucket pivot mounting pin on the arm (without bucket mass).
4. (*) indicates load limited by hydraulic capacity.

LIFTING CAPACITY











 Rating over-front  Rating over-side or 360 degrees

HX140L C

Boom : 4.6 m (15' 1") / Arm : 2.1 m (6' 11") / Shoe : 600 mm (24") triple grouser / Counter weight : 2,000 kg / Dozer none

Load point height m (ft)	Load radius								At max. reach			
	1.5 m (4.9 ft)		3.0 m (9.8 ft)		4.5 m (14.8 ft)		6.0 m (19.7 ft)		Capacity	Reach		
											m (ft)	
6.0 m (19.7 ft)	kg					*3,910	*3,910			*3,470	*3,470	4.97
	lb					*8,620	*8,620			*7,650	*7,650	(16.3)
4.5 m (14.8 ft)	kg					*4,120	4,090			*3,210	2,580	5.99
	lb					*9,080	9,020			*7,080	5,690	(19.7)
3.0 m (9.8 ft)	kg					*7,310	7,220	*5,030	3,890	3,760	2,530	6.52
	lb					*16,120	15,920	*11,090	8,580	8,290	5,580	(21.4)
1.5 m (4.9 ft)	kg					5,670	3,670	5,670	3,670	3,660	2,440	6.67
	lb					12,500	8,090	12,500	8,090	8,070	5,380	(21.9)
Ground Line	kg					*6,160	*6,160	5,520	3,530	3,600	2,380	6.47
	lb					*13,580	*13,580	12,170	7,780	7,940	5,250	(21.2)
-1.5 m (-4.9 ft)	kg	*5,500	*5,500	*9,870	6,460	5,480	3,500			3,700	2,450	5.88
	lb	*12,130	*12,130	*21,760	14,240	12,080	7,720			8,160	5,400	(19.3)
-3.0 m (-9.8 ft)	kg			*8,230	6,600	*5,470	3,590			*5,000	3,340	4.75
	lb			*18,140	14,550	*12,060	7,910			*11,020	7,360	(15.6)

Boom : 4.6 m (15' 1") / Arm : 2.1 m (6' 11") / Shoe : 600 mm (24") triple grouser / Counter weight : 2,000 kg / Dozer down

Load point height m (ft)	Load radius								At max. reach			
	1.5 m (4.9 ft)		3.0 m (9.8 ft)		4.5 m (14.8 ft)		6.0 m (19.7 ft)		Capacity	Reach		
											m (ft)	
6.0 m (19.7 ft)	kg					*3,910	*3,910			*3,470	*3,470	4.97
	lb					*8,620	*8,620			*7,650	*7,650	(16.3)
4.5 m (14.8 ft)	kg					*4,120	*4,120			*3,210	2,940	5.99
	lb					*9,080	*9,080			*7,080	6,480	(19.7)
3.0 m (9.8 ft)	kg					*7,310	*7,310	*5,030	4,430	*4,280	2,880	6.52
	lb					*16,120	*16,120	*11,090	9,770	*9,440	6,350	(21.4)
1.5 m (4.9 ft)	kg					*6,070	4,210	*6,070	4,210	*4,680	2,800	6.67
	lb					*13,380	9,280	*13,380	9,280	*10,320	6,170	(21.9)
Ground Line	kg					*6,160	*6,160	*6,690	4,070	*4,950	2,730	6.47
	lb					*13,580	*13,580	*14,750	8,970	*10,910	6,020	(21.2)
-1.5 m (-4.9 ft)	kg	*5,500	*5,500	*9,870	7,550	*6,630	4,040			*4,820	2,810	5.88
	lb	*12,130	*12,130	*21,760	16,640	*14,620	8,910			*10,630	6,190	(19.3)
-3.0 m (-9.8 ft)	kg			*8,230	7,700	*5,470	4,130			*5,000	3,830	4.75
	lb			*18,140	16,980	*12,060	9,110			*11,020	8,440	(15.6)

Boom : 4.6 m (15' 1") / Arm : 2.1 m (6' 11") / Shoe : 600 mm (24") triple grouser / Counter weight : 2,000 kg / Dozer up

Load point height m (ft)	Load radius								At max. reach	
	1.5 m (4.9 ft)		3.0 m (9.8 ft)		4.5 m (14.8 ft)		6.0 m (19.7 ft)		Capacity	Reach
										

LIFTING CAPACITY

Rating over-front Rating over-side or 360 degrees

HX140L C

Boom : 4.6 m (15' 1") / Arm : 2.1 m (6' 11") / Shoe : 600 mm (24") triple grouser / Counter weight : 2,300 kg / Dozer none

Load point height m (ft)	Load radius								At max. reach		
	1.5 m (4.9 ft)		3.0 m (9.8 ft)		4.5 m (14.8 ft)		6.0 m (19.7 ft)		Capacity	Reach	
6.0 m (19.7 ft)	kg				*3,910	*3,910			*3,470	*3,470	4.97
	lb				*8,620	*8,620			*7,650	*7,650	(16.3)
4.5 m (14.8 ft)	kg				*4,120	*4,120			*3,210	2,730	5.99
	lb				*9,080	*9,080			*7,080	6,020	(19.7)
3.0 m (9.8 ft)	kg		*7,310	*7,310	*5,030	4,100	3,940	2,680	*3,220	2,350	6.52
	lb		*16,120	*16,120	*11,090	9,040	8,690	5,910	*7,100	5,180	(21.4)
1.5 m (4.9 ft)	kg				5,940	3,880	3,850	2,590	3,290	2,220	6.67
	lb				13,100	8,550	8,490	5,710	7,250	4,890	(21.9)
Ground Line	kg		*6,160	*6,160	5,790	3,740	3,780	2,530	3,400	2,290	6.47
	lb		*13,580	*13,580	12,760	8,250	8,330	5,580	7,500	5,050	(21.2)
-1.5 m (-4.9 ft)	kg	*5,500	*5,500	*9,870	6,840	5,750	3,710		3,890	2,600	5.88
	lb	*12,130	*12,130	*21,760	15,080	12,680	8,180		8,580	5,730	(19.3)
-3.0 m (-9.8 ft)	kg			*8,230	6,980	*5,470	3,800		*5,000	3,540	4.75
	lb			*18,140	15,390	*12,060	8,380		*11,020	7,800	(15.6)

Boom : 4.6 m (15' 1") / Arm : 2.1 m (6' 11") / Shoe : 600 mm (24") triple grouser / Counter weight : 2,300 kg / Dozer down

Load point height m (ft)	Load radius								At max. reach		
	1.5 m (4.9 ft)		3.0 m (9.8 ft)		4.5 m (14.8 ft)		6.0 m (19.7 ft)		Capacity	Reach	
6.0 m (19.7 ft)	kg				*3,910	*3,910			*3,470	*3,470	4.97
	lb				*8,620	*8,620			*7,650	*7,650	(16.3)
4.5 m (14.8 ft)	kg				*4,120	*4,120			*3,210	3,090	5.99
	lb				*9,080	*9,080			*7,080	6,810	(19.7)
3.0 m (9.8 ft)	kg		*7,310	*7,310	*5,030	4,650	*4,280	3,040	*3,220	2,670	6.52
	lb		*16,120	*16,120	*11,090	10,250	*9,440	6,700	*7,100	5,890	(21.4)
1.5 m (4.9 ft)	kg				*6,070	4,430	*4,680	2,950	*3,430	2,530	6.67
	lb				*13,380	9,770	*10,320	6,500	*7,560	5,580	(21.9)
Ground Line	kg		*6,160	*6,160	*6,690	4,290	*4,950	2,890	*3,910	2,610	6.47
	lb		*13,580	*13,580	*14,750	9,460	*10,910	6,370	*8,620	5,750	(21.2)
-1.5 m (-4.9 ft)	kg	*5,500	*5,500	*9,870	7,950	*6,630	4,260		*4,820	2,970	5.88
	lb	*12,130	*12,130	*21,760	17,530	*14,620	9,390		*10,630	6,550	(19.3)
-3.0 m (-9.8 ft)	kg			*8,230	8,100	*5,470	4,350		*5,000	4,040	4.75
	lb			*18,140	17,860	*12,060	9,590		*11,020	8,910	(15.6)

Boom : 4.6 m (15' 1") / Arm : 2.1 m (6' 11") / Shoe : 600 mm (24") triple grouser / Counter weight : 2,300 kg / Dozer up

Load point height m (ft)	Load radius								At max. reach		
	1.5 m (4.9 ft)		3.0 m (9.8 ft)		4.5 m (14.8 ft)		6.0 m (19.7 ft)		Capacity	Reach	
6.0 m (19.7 ft)	kg				*3,910	*3,910			*3,470	*3,470	4.97
	lb				*8,620	*8,620			*7,650	*7,650	(16.3)
4.5 m (14.8 ft)	kg				*4,120	*4,120			*3,210	2,870	5.99
	lb				*9,080	*9,080			*7,080	6,330	(19.7)
3.0 m (9.8 ft)	kg		*7,310	*7,310	*5,030	4,300	3,940	2,820	*3,220	2,480	6.52
	lb		*16,120	*16,120	*11,090	9,480	8,690	6,220	*7,100	5,470	(21.4)
1.5 m (4.9 ft)	kg				5,940	4,080	3,840	2,730	3,290	2,350	6.67
	lb				13,100	8,990	8,470	6,020	7,250	5,180	(21.9)
Ground Line	kg		*6,160	*6,160	5,780	3,950	3,780	2,670	3,400	2,410	6.47
	lb		*13,580	*13,580	12,740	8,710	8,330	5,890	7,500	5,310	(21.2)
-1.5 m (-4.9 ft)	kg	*5,500	*5,500	*9,870	7,200	5,750	3,920		3,890	2,740	5.88
	lb	*12,130	*12,130	*21,760	15,870	12,680	8,640		8,580	6,040	(19.3)
-3.0 m (-9.8 ft)	kg			*8,230	7,340	*5,470	4,000		*5,000	3,730	4.75
	lb			*18,140	16,180	*12,060	8,820		*11,020	8,220	(15.6)

1. Lifting capacity are based on ISO 10567.
2. Lifting capacity of the HX series does not exceed 75% of tipping load with the machine on firm, level ground or 87% of full hydraulic capacity.

3. The Lift-point is bucket pivot mounting pin on the arm (without bucket mass).
4. (*) indicates load limited by hydraulic capacity.

LIFTING CAPACITY

Rating over-front Rating over-side or 360 degrees

HX140L C

Boom : 4.6 m (15' 1") / Arm : 2.5 m (8' 2") / Shoe : 600 mm (24") triple grouser / Counter weight : 2,000 kg / Dozer none

Load point height m (ft)	Load radius								At max. reach			
	1.5 m (4.9 ft)		3.0 m (9.8 ft)		4.5 m (14.8 ft)		6.0 m (19.7 ft)		Capacity	Reach		
6.0 m (19.7 ft)	kg								*3,400	*3,400	5.50	
	lb								*7,500	*7,500	(18.0)	
4.5 m (14.8 ft)	kg								*3,700	*3,700	6.44	
	lb								*8,160	*8,160	(21.1)	
3.0 m (9.8 ft)	kg			*6,380	*6,380	*4,630	3,920	3,770	2,540	*2,200	2,010	6.93
	lb			*14,070	*14,070	*10,210	8,640	8,310	5,600	*4,850	4,430	(22.7)
1.5 m (4.9 ft)	kg			*7,050	6,670	5,690	3,680	3,660	2,430	*2,320	1,900	7.07
	lb			*15,540	14,700	12,540	8,110	8,070	5,360	*5,110	4,190	(23.2)
Ground Line	kg			*6,550	6,390	5,500	3,510	3,570	2,350	*2,590	1,950	6.88
	lb			*14,440	14,090	12,130	7,740	7,870	5,180	*5,710	4,300	(22.6)
-1.5 m (-4.9 ft)	kg	*4,890	*4,890	*10,080	6,370	5,430	3,450	3,550	2,330	*3,160	2,170	6.34
	lb	*10,780	*10,780	*22,220	14,040	11,970	7,610	7,830	5,140	*6,970	4,780	(20.8)
-3.0 m (-9.8 ft)	kg	*9,020	*9,020	*8,820	6,480	5,490	3,500			4,300	2,810	5.31
	lb	*19,890	*19,890	*19,440	14,290	12,100	7,720			9,480	6,190	(17.4)

Boom : 4.6 m (15' 1") / Arm : 2.5 m (8' 2") / Shoe : 600 mm (24") triple grouser / Counter weight : 2,000 kg / Dozer down

Load point height m (ft)	Load radius								At max. reach			
	1.5 m (4.9 ft)		3.0 m (9.8 ft)		4.5 m (14.8 ft)		6.0 m (19.7 ft)		Capacity	Reach		
6.0 m (19.7 ft)	kg								*3,400	*3,400	5.50	
	lb								*7,500	*7,500	(18.0)	
4.5 m (14.8 ft)	kg								*3,700	*3,700	6.44	
	lb								*8,160	*8,160	(21.1)	
3.0 m (9.8 ft)	kg			*6,380	*6,380	*4,630	4,470	*4,000	2,890	*2,200	*2,200	6.93
	lb			*14,070	*14,070	*10,210	9,850	*8,820	6,370	*4,850	*4,850	(22.7)
1.5 m (4.9 ft)	kg			*7,050	*7,050	*5,760	4,220	*4,480	2,790	*4,480	2,190	7.07
	lb			*15,540	*15,540	*12,700	9,300	*9,880	6,150	*5,110	4,830	(23.2)
Ground Line	kg			*6,550	*6,550	*6,530	4,050	*4,850	2,710	*2,590	2,240	6.88
	lb			*14,440	*14,440	*14,400	8,930	*10,690	5,970	*5,710	4,940	(22.6)
-1.5 m (-4.9 ft)	kg	*4,890	*4,890	*10,080	7,460	*6,670	3,990	*4,820	2,680	*3,160	2,500	6.34
	lb	*10,780	*10,780	*22,220	16,450	*14,700	8,800	*10,630	5,910	*6,970	5,510	(20.8)
-3.0 m (-9.8 ft)	kg	*9,020	*9,020	*8,820	7,580	*5,920	4,040			*4,580	3,230	5.31
	lb	*19,890	*19,890	*19,440	16,710	*13,050	8,910			*10,100	7,120	(17.4)

Boom : 4.6 m (15' 1") / Arm : 2.5 m (8' 2") / Shoe : 600 mm (24") triple grouser / Counter weight : 2,000 kg / Dozer up

Load point height m (ft)	Load radius								At max. reach			
	1.5 m (4.9 ft)		3.0 m (9.8 ft)		4.5 m (14.8 ft)		6.0 m (19.7 ft)		Capacity	Reach		
6.0 m (19.7 ft)	kg								*3,400	*3,400	5.50	
	lb								*7,500	*7,500	(18.0)	
4.5 m (14.8 ft)	kg								*3,700	*3,700	6.44	
	lb								*8,160	*8,160	(21.1)	
3.0 m (9.8 ft)	kg			*6,380	*6,380	*4,630	4,130	3,770	2,680	*2,200	2,130	6.93
	lb			*14,070	*14,070	*10,210	9,110	8,310	5,910	*4,850	4,700	(22.7)
1.5 m (4.9 ft)	kg			*7,050	7,030	5,690	3,880	3,660	2			

LIFTING CAPACITY

Rating over-front Rating over-side or 360 degrees

HX140L C

Boom : 4.6 m (15' 1") / Arm : 2.5 m (8' 2") / Shoe : 600 mm (24") triple grouser / Counter weight : 2,300 kg / Dozer none

Load point height m (ft)	Load radius								At max. reach			
	1.5 m (4.9 ft)		3.0 m (9.8 ft)		4.5 m (14.8 ft)		6.0 m (19.7 ft)		Capacity	Reach		
6.0 m (19.7 ft)	kg				*3,400	*3,400			*2,390	*2,390	5.50	
	lb				*7,500	*7,500			*5,270	*5,270	(18.0)	
4.5 m (14.8 ft)	kg				*3,700	*3,700	*3,500	2,750	*2,210	*2,210	6.44	
	lb				*8,160	*8,160	*7,720	6,060	*4,870	*4,870	(21.1)	
3.0 m (9.8 ft)	kg		*6,380	*6,380	*4,630	4,130	3,950	2,680	*2,200	2,130	6.93	
	lb		*14,070	*14,070	*10,210	9,110	8,710	5,910	*4,850	4,700	(22.7)	
1.5 m (4.9 ft)	kg		*7,050	7,050	*5,760	3,890	3,840	2,580	*2,320	2,020	7.07	
	lb		*15,540	15,540	*12,700	8,580	8,470	5,690	*5,110	4,450	(23.2)	
Ground Line	kg		*6,550	*6,550	5,770	3,720	3,750	2,500	*2,590	2,070	6.88	
	lb		*14,440	*14,440	12,720	8,200	8,270	5,510	*5,710	4,560	(22.6)	
-1.5 m (-4.9 ft)	kg	*4,890	*4,890	*10,080	6,750	5,700	3,660	3,730	2,480	*3,160	2,310	6.34
	lb	*10,780	*10,780	*22,220	14,880	12,570	8,070	8,220	5,470	*6,970	5,090	(20.8)
-3.0 m (-9.8 ft)	kg	*9,020	*9,020	*8,820	6,860	5,760	3,710			4,510	2,980	5.31
	lb	*19,890	*19,890	*19,440	15,120	12,700	8,180			9,940	6,570	(17.4)

Boom : 4.6 m (15' 1") / Arm : 2.5 m (8' 2") / Shoe : 600 mm (24") triple grouser / Counter weight : 2,300 kg / Dozer down

Load point height m (ft)	Load radius								At max. reach			
	1.5 m (4.9 ft)		3.0 m (9.8 ft)		4.5 m (14.8 ft)		6.0 m (19.7 ft)		Capacity	Reach		
6.0 m (19.7 ft)	kg				*3,400	*3,400			*2,390	*2,390	5.50	
	lb				*7,500	*7,500			*5,270	*5,270	(18.0)	
4.5 m (14.8 ft)	kg				*3,700	*3,700	*3,500	3,110	*2,210	*2,210	6.44	
	lb				*8,160	*8,160	*7,720	6,860	*4,870	*4,870	(21.1)	
3.0 m (9.8 ft)	kg		*6,380	*6,380	*4,630	*4,630	*4,000	3,040	*2,200	*2,200	6.93	
	lb		*14,070	*14,070	*10,210	*10,210	*8,820	6,700	*4,850	*4,850	(22.7)	
1.5 m (4.9 ft)	kg		*7,050	*7,050	*5,760	4,440	*4,480	2,940	*2,320	2,310	7.07	
	lb		*15,540	*15,540	*12,700	9,790	*9,880	6,480	*5,110	5,090	(23.2)	
Ground Line	kg		*6,550	*6,550	*6,530	4,270	*4,850	2,860	*2,590	2,370	6.88	
	lb		*14,440	*14,440	*14,400	9,410	*10,690	6,310	*5,710	5,220	(22.6)	
-1.5 m (-4.9 ft)	kg	*4,890	*4,890	*10,080	7,860	*6,670	4,210	*4,820	2,830	*3,160	2,640	6.34
	lb	*10,780	*10,780	*22,220	17,330	*14,700	9,280	*10,630	6,240	*6,970	5,820	(20.8)
-3.0 m (-9.8 ft)	kg	*9,020	*9,020	*8,820	7,980	*5,920	4,260			*4,580	3,410	5.31
	lb	*19,890	*19,890	*19,440	17,590	*13,050	9,390			*10,100	7,520	(17.4)

Boom : 4.6 m (15' 1") / Arm : 2.5 m (8' 2") / Shoe : 600 mm (24") triple grouser / Counter weight : 2,300 kg / Dozer up

Load point height m (ft)	Load radius								At max. reach			
	1.5 m (4.9 ft)		3.0 m (9.8 ft)		4.5 m (14.8 ft)		6.0 m (19.7 ft)		Capacity	Reach		
6.0 m (19.7 ft)	kg				*3,400	*3,400			*2,390	*2,390	5.50	
	lb				*7,500	*7,500			*5,270	*5,270	(18.0)	
4.5 m (14.8 ft)	kg				*3,700	*3,700	*3,500	2,890	*2,210	*2,210	6.44	
	lb				*8,160	*8,160	*7,720	6,370	*4,870	*4,870	(21.1)	
3.0 m (9.8 ft)	kg		*6,380	*6,380	*4,630	4,340	3,950	2,820	*2,200	*2,200	6.93	
	lb		*14,070	*14,070	*10,210	9,570	8,710	6,220	*4,850	*4,850	(22.7)	
1.5 m (4.9 ft)	kg		*7,050	*7,050	*5,760	4,090	3,840	2,720	*2,320	2,140	7.07	
	lb		*15,540	*15,540	*12,700	9,020	8,470	6,000	*5,110	4,720	(23.2)	
Ground Line	kg		*6,550	*6,550	5,770	3,930	3,750	2,640	*2,590	2,190	6.88	
	lb		*14,440	*14,440	12,720	8,660	8,270	5,820	*5,710	4,830	(22.6)	
-1.5 m (-4.9 ft)	kg	*4,890	*4,890	*10,080	7,110	5,700	3,870	3,720	2,620	*3,160	2,440	6.34
	lb	*10,780	*10,780	*22,220	15,670	12,570	8,530	8,200	5,780	*6,970	5,380	(20.8)
-3.0 m (-9.8 ft)	kg	*9,020	*9,020	*8,820	7,220	5,760	3,920			4,510	3,150	5.31
	lb	*19,890	*19,890	*19,440	15,920	12,700	8,640			9,940	6,940	(17.4)

1. Lifting capacity are based on ISO 10567.
2. Lifting capacity of the HX series does not exceed 75% of tipping load with the machine on firm, level ground or 87% of full hydraulic capacity.

3. The Lift-point is bucket pivot mounting pin on the arm (without bucket mass).
4. (*) indicates load limited by hydraulic capacity.

LIFTING CAPACITY

Rating over-front Rating over-side or 360 degrees

HX140L C

Boom : 4.6 m (15' 1") / Arm : 3.0 m (9' 10") / Shoe : 600 mm (24") triple grouser / Counter weight : 2,000 kg / Dozer none

Load point height m (ft)	Load radius								At max. reach			
	1.5 m (4.9 ft)		3.0 m (9.8 ft)		4.5 m (14.8 ft)		6.0 m (19.7 ft)		Capacity	Reach		
6.0 m (19.7 ft)	kg								*2,230	*2,230	6.08	
	lb								*4,920	*4,920	(20.0)	
4.5 m (14.8 ft)	kg								*3,280	2,640	6.94	
	lb								*7,230	5,820	(22.8)	
3.0 m (9.8 ft)	kg			*5,250	*5,250	*4,130	3,990	*3,670	2,560	*1,870	1,810	7.40
	lb			*11,570	*11,570	*9,110	8,800	*8,090	5,640	*4,120	3,990	(24.3)
1.5 m (4.9 ft)	kg			*8,390	6,840	*5,340	3,720	3,670	2,440	*1,970	1,720	7.53
	lb			*18,500	15,080	*11,770	8,200	8,090	5,380	*4,340	3,790	(24.7)
Ground Line	kg			*7,180	6,420	5,510	3,520	3,560	2,340	*2,180	1,750	7.36
	lb			*15,830	14,150	12,150	7,760	7,850	5,160	*4,810	3,860	(24.1)
-1.5 m (-4.9 ft)	kg	*4,370	*4,370	*9,280	6,320	5,400	3,430	3,510	2,290	*2,610	1,920	6.85
	lb	*9,630	*9,630	*20,460	13,930	11,900	7,560	7,740	5,050	*5,750	4,230	(22.5)
-3.0 m (-9.8 ft)	kg	*7,550	*7,550	*9,420	6,380	5,420	3,440			*3,560	2,380	5.91
	lb	*16,640	*16,640	*20,770	14,070	11,950	7,580			*7,850	5,250	(19.4)

Boom : 4.6 m (15' 1") / Arm : 3.0 m (9' 10") / Shoe : 600 mm (24") triple grouser / Counter weight : 2,000 kg / Dozer down

Load point height m (ft)	Load radius								At max. reach			
	1.5 m (4.9 ft)		3.0 m (9.8 ft)		4.5 m (14.8 ft)		6.0 m (19.7 ft)		Capacity	Reach		
6.0 m (19.7 ft)	kg								*2,230	*2,230	6.08	
	lb								*4,920	*4,920	(20.0)	
4.5 m (14.8 ft)	kg								*3,280	3,000	6.94	
	lb								*7,230	6,610	(22.8)	
3.0 m (9.8 ft)	kg			*5,250	*5,250	*4,130	*4,130	*3,670	2,910	*1,870	*1,870	7.40
	lb			*11,570	*11,570	*9,110	*9,110	*8,090	6,420	*4,120	*4,120	(24.3)
1.5 m (4.9 ft)	kg			*8,390	7,960	*5,340	4,270	*4,220	2,800	*1,970	*1,970	7.53
	lb			*18,500	17,550	*11,770	9,410	*9,300	6,170	*4,340	*4,340	(24.7)
Ground Line	kg			*7,180	*7,180	*6,290	4,060	*4,700	2,700	*2,180	2,020	7.36
	lb			*15,830	*15,830	*13,870	8,950	*10,360	5,950	*4,810	4,450	(24.1)
-1.5 m (-4.9 ft)	kg	*4,370	*4,370	*9,280	7,410	*6,660	3,960	*4,860	2,650	*2,610	2,220	6.85
	lb	*9,630	*9,630	*20,460	16,340	*14,680	8,730	*10,710	5,840	*5,750	4,890	(22.5)
-3.0 m (-9.8 ft)	kg	*7,550	*7,550	*9,420	7,480	*6,270	3,970			*3,560	2,740	5.91
	lb	*16,640	*16,640	*20,770	16,490	*13,820	8,750			*7,850	6,040	(19.4)

Boom : 4.6 m (15' 1") / Arm : 3.0 m (9' 10") / Shoe : 600 mm (24") triple grouser / Counter weight : 2,000 kg / Dozer up

Load point height m (ft)	Load radius								At max. reach		
	1.5 m (4.9 ft)		3.0 m (9.8 ft)		4.5 m (14.8 ft)		6.0 m (19.7 ft)		Capacity	Reach	
6.0 m (19.7 ft)	kg								*2,230	*2,230	6.08
	lb								*4,920	*4,920	(20.0)
4.5 m (14.8 ft)	kg								*3,280	2,780	6.94
	lb								*7,230	6,130	(22.8)
3.0 m (

LIFTING CAPACITY

Rating over-front Rating over-side or 360 degrees

HX140L C

Boom : 4.6 m (15' 1") / Arm : 3.0 m (9' 10") / Shoe : 600 mm (24") triple grouser / Counter weight : 2,300 kg / Dozer none

Load point height m (ft)	Load radius								At max. reach			
	1.5 m (4.9 ft)		3.0 m (9.8 ft)		4.5 m (14.8 ft)		6.0 m (19.7 ft)		Capacity	Reach		
6.0 m (19.7 ft)	kg							*2,230	*2,230	*2,000	*2,000	6.08
	lb							*4,920	*4,920	*4,410	*4,410	(20.0)
4.5 m (14.8 ft)	kg							*3,280	2,790	*1,880	*1,880	6.94
	lb							*7,230	6,150	*4,140	*4,140	(22.8)
3.0 m (9.8 ft)	kg		*5,250	*5,250	*4,130	*4,130	*3,670	2,700	*1,870	*1,870	7.40	
	lb		*11,570	*11,570	*9,110	*9,110	*8,090	5,950	*4,120	*4,120	(24.3)	
1.5 m (4.9 ft)	kg		*8,390	7,220	*5,340	3,930	3,850	2,590	*1,970	1,830	7.53	
	lb		*18,500	15,920	*11,770	8,660	8,490	5,710	*4,340	4,030	(24.7)	
Ground Line	kg		*7,180	6,800	5,780	3,730	3,740	2,490	*2,180	1,860	7.36	
	lb		*15,830	14,990	12,740	8,220	8,250	5,490	*4,810	4,100	(24.1)	
-1.5 m (-4.9 ft)	kg	*4,370	*4,370	*9,280	6,690	5,680	3,640	3,690	2,440	*2,610	2,050	6.85
	lb	*9,630	*9,630	*20,460	14,750	12,520	8,020	8,140	5,380	*5,750	4,520	(22.5)
-3.0 m (-9.8 ft)	kg	*7,550	*7,550	*9,420	6,760	5,690	3,650			*3,560	2,530	5.91
	lb	*16,640	*16,640	*20,770	14,900	12,540	8,050			*7,850	5,580	(19.4)

Boom : 4.6 m (15' 1") / Arm : 3.0 m (9' 10") / Shoe : 600 mm (24") triple grouser / Counter weight : 2,300 kg / Dozer down

Load point height m (ft)	Load radius								At max. reach			
	1.5 m (4.9 ft)		3.0 m (9.8 ft)		4.5 m (14.8 ft)		6.0 m (19.7 ft)		Capacity	Reach		
6.0 m (19.7 ft)	kg							*2,230	*2,230	*2,000	*2,000	6.08
	lb							*4,920	*4,920	*4,410	*4,410	(20.0)
4.5 m (14.8 ft)	kg							*3,280	3,150	*1,880	*1,880	6.94
	lb							*7,230	6,940	*4,140	*4,140	(22.8)
3.0 m (9.8 ft)	kg		*5,250	*5,250	*4,130	*4,130	*3,670	3,060	*1,870	*1,870	7.40	
	lb		*11,570	*11,570	*9,110	*9,110	*8,090	6,750	*4,120	*4,120	(24.3)	
1.5 m (4.9 ft)	kg		*8,390	8,360	*5,340	4,490	*4,220	2,950	*1,970	*1,970	7.53	
	lb		*18,500	18,430	*11,770	9,900	*9,300	6,500	*4,340	*4,340	(24.7)	
Ground Line	kg		*7,180	*7,180	*6,290	4,280	*4,700	2,850	*2,180	2,140	7.36	
	lb		*15,830	*15,830	*13,870	9,440	*10,360	6,280	*4,810	4,720	(24.1)	
-1.5 m (-4.9 ft)	kg	*4,370	*4,370	*9,280	7,810	*6,660	4,180	*4,860	2,800	*2,610	2,350	6.85
	lb	*9,630	*9,630	*20,460	17,220	*14,680	9,220	*10,710	6,170	*5,750	5,180	(22.5)
-3.0 m (-9.8 ft)	kg	*7,550	*7,550	*9,420	7,880	*6,270	4,190			*3,560	2,890	5.91
	lb	*16,640	*16,640	*20,770	17,370	*13,820	9,240			*7,850	6,370	(19.4)

Boom : 4.6 m (15' 1") / Arm : 3.0 m (9' 10") / Shoe : 600 mm (24") triple grouser / Counter weight : 2,300 kg / Dozer up

Load point height m (ft)	Load radius								At max. reach			
	1.5 m (4.9 ft)		3.0 m (9.8 ft)		4.5 m (14.8 ft)		6.0 m (19.7 ft)		Capacity	Reach		
6.0 m (19.7 ft)	kg							*2,230	*2,230	*2,000	*2,000	6.08
	lb							*4,920	*4,920	*4,410	*4,410	(20.0)
4.5 m (14.8 ft)	kg							*3,280	2,930	*1,880	*1,880	6.94
	lb							*7,230	6,460	*4,140	*4,140	(22.8)
3.0 m (9.8 ft)	kg		*5,250	*5,250	*4,130	*4,130	*3,670	2,840	*1,870	*1,870	7.40	
	lb		*11,570	*11,570	*9,110	*9,110	*8,090	6,260	*4,120	*4,120	(24.3)	
1.5 m (4.9 ft)	kg		*8,390	7,580	*5,340	4,140	3,850	2,730	*1,970	1,940	7.53	
	lb		*18,500	16,710	*11,770	9,130	8,490	6,020	*4,340	4,280	(24.7)	
Ground Line	kg		*7,180	7,160	5,780	3,930	3,740	2,630	*2,180	1,970	7.36	
	lb		*15,830	15,790	12,740	8,660	8,250	5,800	*4,810	4,340	(24.1)	
-1.5 m (-4.9 ft)	kg	*4,370	*4,370	*9,280	7,060	5,670	3,840	3,690	2,580	*2,610	2,170	6.85
	lb	*9,630	*9,630	*20,460	15,560	12,500	8,470	8,140	5,690	*5,750	4,780	(22.5)
-3.0 m (-9.8 ft)	kg	*7,550	*7,550	*9,420	7,120	5,690	3,850			*3,560	2,670	5.91
	lb	*16,640	*16,640	*20,770	15,700	12,540	8,490			*7,850	5,890	(19.4)

1. Lifting capacity are based on ISO 10567.
2. Lifting capacity of the HX series does not exceed 75% of tipping load with the machine on firm, level ground or 87% of full hydraulic capacity.

3. The Lift-point is bucket pivot mounting pin on the arm (without bucket mass).
4. (*) indicates load limited by hydraulic capacity.

LIFTING CAPACITY

Rating over-front Rating over-side or 360 degrees

HX140L C 2-PIECE BOOM

Boom : 4.9 m (16' 1") / Arm : 1.9 m (6' 3") / Shoe : 600 mm (24") triple grouser / Counter weight : 2,300 kg / Dozer none

Load point height m (ft)	Load radius								At max. reach			
	3.0 m (9.8 ft)		4.5 m (14.8 ft)		6.0 m (19.7 ft)		7.5 m (24.6 ft)		Capacity	Reach		
7.5 m (24.6 ft)	kg									*4,720	*4,720	3.42
	lb									*10,410	*10,410	(11.2)
6.0 m (19.7 ft)	kg									*4,310	3,380	5.27
	lb									*9,500	7,450	(17.3)
4.5 m (14.8 ft)	kg		*5,420	*5,420	*4,480	4,280	4,020	2,730		3,760	2,550	6.24
	lb		*11,950	*11,950	*9,880	9,440	8,860	6,020		8,290	5,620	(20.5)
3.0 m (9.8 ft)	kg				*5,550	4,040	3,950	2,660		3,280	2,220	6.75
	lb				*12,240	8,910	8,710	5,860		7,230	4,890	(22.1)
1.5 m (4.9 ft)	kg				5,900	3,810	3,840	2,570		3,130	2,100	6.89
	lb				13,010	8,400	8,470	5,670		6,900	4,630	(22.6)
Ground Line	kg				5,760	3,690	3,770	2,500		3,230	2,160	6.70
	lb				12,700	8,140	8,310	5,510		7,120	4,760	(22.0)
-1.5 m (-4.9 ft)	kg	*9,520	6,800		5,740	3,670	3,770	2,500		3,670	2,440	6.13
	lb	*20,990	14,990		12,650	8,090	8,310	5,510		8,090	5,380	(20.1)
-3.0 m (-9.8 ft)	kg											
	lb											

Boom : 4.9 m (16' 1") / Arm : 1.9 m (6' 3") / Shoe : 600 mm (24") triple grouser / Counter weight : 2,300 kg / Dozer down

Load point height m (ft)	Load radius								At max. reach			
	3.0 m (9.8 ft)		4.5 m (14.8 ft)		6.0 m (19.7 ft)		7.5 m (24.6 ft)		Capacity	Reach		
7.5 m (24.6 ft)	kg									*4,720	*4,720	3.42
	lb									*10,410	*10,410	(11.2)
6.0 m (19.7 ft)	kg									*4,310	3,820	5.27
	lb									*9,500	8,420	(17.3)
4.5 m (14.8 ft)	kg		*5,420	*5,420	*4,480	*4,480	*4,240	3,100		*3,980	2,900	6.24
	lb		*11,950	*11,950	*9,880	*9,880	*9,350	6,830		*8,770	6,390	(20.5)
3.0 m (9.8 ft)	kg				*5,550	4,600	*4,550	3,020		*3,940	2,530	6.75
	lb				*12,240	10,140	*10,030	6,660		*8,690	5,580	(22.1)
1.5 m (4.9 ft)	kg				*6,670	4,360	*5,030	2,930		*4,110	2,400	6.89
	lb				*14,700	9,610	*11,090	6,460		*9,060	5,290	(22.6)
Ground Line	kg				*7,270	4,240	*5,360	2,860		*4,560	2,470	6.70
	lb				*16,030	9,350	*11,820	6,310		*10,050	5,450	(22.0)
-1.5 m (-4.9 ft)	kg	*9,520	7,930		*7,220	4,220	*5,210	2,870		*5,030	2,790	6.13
	lb	*20,990	17,480		*15,920	9,300	*11,490	6,330		*11,090	6,150	(20.1)
-3.0 m (-9.8 ft)	kg											
	lb											

Boom : 4.9 m (16' 1") / Arm : 1.9 m (6' 3") / Shoe : 600 mm (24") triple grouser / Counter weight : 2,300 kg / Dozer up

Load point height m (ft)	Load radius								At max. reach			
	3.0 m (9.8 ft)		4.5 m (14.8 ft)		6.0 m (19.7 ft)		7.5 m (24.6 ft)		Capacity	Reach		
7.5 m (24.6 ft)	kg									*4,720	*4,720	3.42
	lb									*10,410	*10,410	(11.2)
6.0 m (19.7 ft)	kg									*4,310	3,540	5.27
	lb									*9,500	7,800	(17.3)
4.5 m (14.8 ft)	kg		*5,420	*5,420	*4,480	*4,480	4,020	2,870		3,760	2,690	6.24
	lb		*11,950	*11,950	*9,880	*9,880	8,860	6,330		8,290	5,930	(20.5)
3.0 m (9.8 ft)	kg				*5,550	4,250	3,940	2,800		3,280	2,340	6.75
	lb				*12,240	9,370	8,690	6,170		7,230	5,160	(22.1)
1.5 m (4.9 ft)	kg				5,890	4,010	3,840	2,710		3,130	2,220	6.89
	lb											

LIFTING CAPACITY

Rating over-front Rating over-side or 360 degrees

HX140L C 2-PIECE BOOM

Boom : 4.9 m (16' 1") / Arm : 2.1 m (6' 11") / Shoe : 600 mm (24") triple grouser / Counter weight : 2,300 kg / Dozer none

Load point height m (ft)	Load radius								At max. reach		
	3.0 m (9.8 ft)		4.5 m (14.8 ft)		6.0 m (19.7 ft)		7.5 m (24.6 ft)		Capacity	Reach	
7.5 m (24.6 ft)	kg								*4,380	*4,380	3.77
	lb								*9,660	*9,660	(12.4)
6.0 m (19.7 ft)	kg		*3,810	*3,810					*4,110	3,160	5.50
	lb		*8,400	*8,400					*9,060	6,970	(18.0)
4.5 m (14.8 ft)	kg	*5,010	*5,010	*4,260	*4,260	4,030	2,740		3,580	2,430	6.44
	lb	*11,050	*11,050	*9,390	*9,390	8,880	6,040		7,890	5,360	(21.1)
3.0 m (9.8 ft)	kg		*5,340	4,050	3,940	2,660			3,150	2,120	6.93
	lb		*11,770	8,930	8,690	5,860			6,940	4,670	(22.7)
1.5 m (4.9 ft)	kg		5,900	3,810	3,830	2,550			3,000	2,010	7.07
	lb		13,010	8,400	8,440	5,620			6,610	4,430	(23.2)
Ground Line	kg		5,740	3,670	3,750	2,480			3,090	2,060	6.88
	lb		12,650	8,090	8,270	5,470			6,810	4,540	(22.6)
-1.5 m (-4.9 ft)	kg	*9,240	6,730	5,710	3,640	3,740	2,470		3,480	2,310	6.33
	lb	*20,370	14,840	12,590	8,020	8,250	5,450		7,670	5,090	(20.8)
-3.0 m (-9.8 ft)	kg			5,800	3,720						
	lb			12,790	8,200						

Boom : 4.9 m (16' 1") / Arm : 2.1 m (6' 11") / Shoe : 600 mm (24") triple grouser / Counter weight : 2,300 kg / Dozer down

Load point height m (ft)	Load radius								At max. reach		
	3.0 m (9.8 ft)		4.5 m (14.8 ft)		6.0 m (19.7 ft)		7.5 m (24.6 ft)		Capacity	Reach	
7.5 m (24.6 ft)	kg								*4,380	*4,380	3.77
	lb								*9,660	*9,660	(12.4)
6.0 m (19.7 ft)	kg		*3,810	*3,810					*4,110	3,570	5.50
	lb		*8,400	*8,400					*9,060	7,870	(18.0)
4.5 m (14.8 ft)	kg	*5,010	*5,010	*4,260	*4,260	*4,050	3,100		*3,830	2,760	6.44
	lb	*11,050	*11,050	*9,390	*9,390	*8,930	6,830		*8,440	6,080	(21.1)
3.0 m (9.8 ft)	kg		*5,340	4,610	*4,410	3,020			*3,800	2,420	6.93
	lb		*11,770	10,160	*9,720	6,660			*8,380	5,340	(22.7)
1.5 m (4.9 ft)	kg		*6,500	4,360	*4,920	2,910			*3,980	2,300	7.07
	lb		*14,330	9,610	*10,850	6,420			*8,770	5,070	(23.2)
Ground Line	kg		*7,190	4,220	*5,300	2,840			*4,410	2,360	6.88
	lb		*15,850	9,300	*11,680	6,260			*9,720	5,200	(22.6)
-1.5 m (-4.9 ft)	kg	*9,240	7,860	*7,230	4,190	*5,260	2,830		*4,880	2,650	6.33
	lb	*20,370	17,330	*15,940	9,240	*11,600	6,240		*10,760	5,840	(20.8)
-3.0 m (-9.8 ft)	kg			*6,420	4,270						
	lb			*14,150	9,410						

Boom : 4.9 m (16' 1") / Arm : 2.1 m (6' 11") / Shoe : 600 mm (24") triple grouser / Counter weight : 2,300 kg / Dozer up

Load point height m (ft)	Load radius								At max. reach		
	3.0 m (9.8 ft)		4.5 m (14.8 ft)		6.0 m (19.7 ft)		7.5 m (24.6 ft)		Capacity	Reach	
7.5 m (24.6 ft)	kg								*4,380	*4,380	3.77
	lb								*9,660	*9,660	(12.4)
6.0 m (19.7 ft)	kg		*3,810	*3,810					*4,110	3,320	5.50
	lb		*8,400	*8,400					*9,060	7,320	(18.0)
4.5 m (14.8 ft)	kg	*5,010	*5,010	*4,260	*4,260	4,030	2,880		3,580	2,560	6.44
	lb	*11,050	*11,050	*9,390	*9,390	8,880	6,350		7,890	5,640	(21.1)
3.0 m (9.8 ft)	kg		*5,340	4,260	3,940	2,800			3,140	2,240	6.93
	lb		*11,770	9,390	8,690	6,170			6,920	4,940	(22.7)
1.5 m (4.9 ft)	kg		5,890	4,010	3,830	2,690			3,000	2,130	7.07
	lb		12,990	8,840	8,440	5,930			6,610	4,700	(23.2)
Ground Line	kg		5,730	3,870	3,750	2,620			3,090	2,180	6.88
	lb		12,630	8,530	8,270	5,780			6,810	4,810	(22.6)
-1.5 m (-4.9 ft)	kg	*9,240	7,100	5,700	3,840	3,740	2,610		3,480	2,440	6.33
	lb	*20,370	15,650	12,570	8,470	8,250	5,750		7,670	5,380	(20.8)
-3.0 m (-9.8 ft)	kg			5,790	3,920						
	lb			12,760	8,640						

LIFTING CAPACITY

Rating over-front Rating over-side or 360 degrees

HX140L C 2-PIECE BOOM

Boom : 4.9 m (16' 1") / Arm : 2.5 m (8' 2") / Shoe : 600 mm (24") triple grouser / Counter weight : 2,300 kg / Dozer none

Load point height m (ft)	Load radius								At max. reach		
	3.0 m (9.8 ft)		4.5 m (14.8 ft)		6.0 m (19.7 ft)		7.5 m (24.6 ft)		Capacity	Reach	
7.5 m (24.6 ft)	kg								*3,500	*3,500	4.50
	lb								*7,720	*7,720	(14.8)
6.0 m (19.7 ft)	kg			*3,340	*3,340	*2,970	2,760		*2,890	2,750	6.01
	lb			*7,360	*7,360	*6,550	6,080		*6,370	6,060	(19.7)
4.5 m (14.8 ft)	kg		*3,840	*3,840	*3,710	2,760			*2,680	2,180	6.88
	lb		*8,470	*8,470	*8,180	6,080			*5,910	4,810	(22.6)
3.0 m (9.8 ft)	kg		*4,930	4,090	3,950	2,660			*2,640	1,930	7.35
	lb		*10,870	9,020	8,710	5,860			*5,820	4,250	(24.1)
1.5 m (4.9 ft)	kg		5,920	3,820	3,820	2,540			*2,740	1,840	7.48
	lb		13,050	8,420	8,420	5,600			*6,040	4,060	(24.5)
Ground Line	kg	*4,510	*4,510	5,720	3,640	3,720	2,450		2,820	1,870	7.30
	lb	*9,940	*9,940	12,610	8,020	8,200	5,400		6,220	4,120	(23.9)
-1.5 m (-4.9 ft)	kg	*8,370	6,630	5,650	3,590	3,690	2,420		3,120	2,070	6.78
	lb	*18,450	14,620	12,460	7,910	8,140	5,340		6,880	4,560	(22.3)
-3.0 m (-9.8 ft)	kg	*9,850	6,750	5,710	3,640				3,910	2,580	5.84
	lb	*21,720	14,880	12,590	8,020				8,620	5,690	(19.2)

Boom : 4.9 m (16' 1") / Arm : 2.5 m (8' 2") / Shoe : 600 mm (24") triple grouser / Counter weight : 2,300 kg / Dozer down

Load point height m (ft)	Load radius								At max. reach		
	3.0 m (9.8 ft)		4.5 m (14.8 ft)		6.0 m (19.7 ft)		7.5 m (24.6 ft)		Capacity	Reach	
7.5 m (24.6 ft)	kg								*3,500	*3,500	4.50
	lb								*7,720	*7,720	(14.8)
6.0 m (19.7 ft)	kg			*3,340	*3,340	*2,970	*2,970		*2,890	*2,890	6.01
	lb			*7,360	*7,360	*6,550	*6,550		*6,370	*6,370	(19.7)
4.5 m (14.8 ft)	kg		*3,840	*3,840	*3,710	3,130			*2,680	2,480	6.88
	lb		*8,470	*8,470	*8,180	6,900			*5,910	5,470	(22.6)
3.0 m (9.8 ft)	kg		*4,930	4,650	*4,140	3,030			*2,640	2,200	7.35
	lb		*10,870	10,250	*9,130	6,680			*5,820	4,850	(24.1)
1.5 m (4.9 ft)	kg		*6,170	4,370	*4,710	2,910			*2,740	2,110	7.48
	lb		*13,600	9,630	*10,380	6,420			*6,040	4,650	(24.5)
Ground Line	kg	*4,510	*4,510	*7,010	4,190	*5,170	2,810		*2,990	2,150	7.30
	lb	*9,940	*9,940	*15,450	9,240	*11,400	6,190		*6,590	4,740	(23.9)
-1.5 m (-4.9 ft)	kg	*8,370	7,750	*7,230	4,140	*5,290	2,780		*3,490	2,370	6.78
	lb	*18,450	17,090	*15,940	9,130	*11,660	6,130		*7,690	5,220	(22.3)
-3.0 m (-9.8 ft)	kg	*9,850	7,880	*6,710	4,190				*4,610	2,950	5.84
	lb	*21,720	17,370	*14,790	9,240				*10,160	6,500	(19.2)

Boom : 4.9 m (16' 1") / Arm : 2.5 m (8' 2") / Shoe : 600 mm (24") triple grouser / Counter weight : 2,300 kg / Dozer up











Load point height m (ft)	Load radius								At max. reach		
	3.0 m (9.8 ft)		4.5 m (14.8 ft)		6.0 m (19.7 ft)		7.5 m (24.6 ft)		Capacity	Reach	
7.5 m (24.6 ft)	kg								*3,500	*3,500	4.50
	lb								*7,720	*7,720	(14.8)
6.0 m (19.7 ft)	kg			*3,340	*3,340	*2,970	2,900	</			

LIFTING CAPACITY











 Rating over-front  Rating over-side or 360 degrees

HX140HW C

Boom : 4.6 m (15' 1") / Arm : 1.9 m (6' 3") / Shoe : 800 mm (32") triple grouser / Counter weight : 2,000 kg

Load point height m (ft)	Load radius								At max. reach		
	1.5 m (4.9 ft)		3.0 m (9.8 ft)		4.5 m (14.8 ft)		6.0 m (19.7 ft)		Capacity	Reach	
											m (ft)
6.0 m (19.7 ft)	kg				*4,200	*4,200			*3,650	*3,650	4.73
	lb				*9,260	*9,260			*8,050	*8,050	(15.5)
4.5 m (14.8 ft)	kg				*4,330	*4,330			*3,340	3,080	5.80
	lb				*9,550	*9,550			*7,360	6,790	(19.0)
3.0 m (9.8 ft)	kg				*5,220	4,380	4,310	2,880	*3,330	2,640	6.35
	lb				*11,510	9,660	9,500	6,350	*7,340	5,820	(20.8)
1.5 m (4.9 ft)	kg				*4,220	4,170	4,220	2,800	*3,540	2,500	6.50
	lb				*13,710	9,190	9,300	6,170	*7,800	5,510	(21.3)
Ground Line	kg				*5,750	*5,750	6,350	4,050	3,900	2,580	6.29
	lb				*12,680	*12,680	14,000	8,930	8,600	5,690	(20.6)
-1.5 m (-4.9 ft)	kg	*5,700	*5,700	*9,710	7,400	6,330	4,030		4,500	2,960	5.68
	lb	*12,570	*12,570	*21,410	16,310	13,960	8,880		9,920	6,530	(18.6)
-3.0 m (-9.8 ft)	kg			*7,880	7,560	*5,100	4,150		*5,080	4,140	4.51
	lb			*17,370	16,670	*11,240	9,150		*11,200	9,130	(14.8)



Boom : 4.6 m (15' 1") / Arm : 2.1 m (6' 11") / Shoe : 800 mm (32") triple grouser / Counter weight : 2,000 kg

Load point height m (ft)	Load radius								At max. reach		
	1.5 m (4.9 ft)		3.0 m (9.8 ft)		4.5 m (14.8 ft)		6.0 m (19.7 ft)		Capacity	Reach	
											m (ft)
6.0 m (19.7 ft)	kg				*3,910	*3,910			*3,470	*3,470	4.97
	lb				*8,620	*8,620			*7,650	*7,650	(16.3)
4.5 m (14.8 ft)	kg				*4,120	*4,120			*3,210	2,930	5.99
	lb				*9,080	*9,080			*7,080	6,460	(19.7)
3.0 m (9.8 ft)	kg				*7,310	*7,310	*5,030	4,390	*4,280	2,870	6.52
	lb				*16,120	*16,120	*11,090	9,680	*9,440	6,330	(21.4)
1.5 m (4.9 ft)	kg				*6,070	4,170	4,210	2,790	*3,430	2,400	6.67
	lb				*13,380	9,190	9,280	6,150	*7,560	5,290	(21.9)
Ground Line	kg				*6,160	*6,160	6,330	4,030	3,730	2,470	6.47
	lb				*13,580	*13,580	13,960	8,880	8,220	5,450	(21.2)
-1.5 m (-4.9 ft)	kg	*5,500	*5,500	*9,870	7,340	6,300	4,000		4,260	2,800	5.88
	lb	*12,130	*12,130	*21,760	16,180	13,890	8,820		9,390	6,170	(19.3)
-3.0 m (-9.8 ft)	kg			*8,230	7,490	*5,470	4,090		*5,000	3,800	4.75
	lb			*18,140	16,510	*12,060	9,020		*11,020	8,380	(15.6)

- Lifting capacity are based on ISO 10567.
- Lifting capacity of the HX series does not exceed 75% of tipping load with the machine on firm, level ground or 87% of full hydraulic capacity.











- The Lift-point is bucket pivot mounting pin on the arm (without bucket mass).
- (*) indicates load limited by hydraulic capacity.

LIFTING CAPACITY











 Rating over-front  Rating over-side or 360 degrees

HX140HW C

Boom : 4.6 m (15' 1") / Arm : 2.5 m (8' 2") / Shoe : 800 mm (32") triple grouser / Counter weight : 2,000 kg

Load point height m (ft)	Load radius								At max. reach				
	1.5 m (4.9 ft)		3.0 m (9.8 ft)		4.5 m (14.8 ft)		6.0 m (19.7 ft)		Capacity	Reach			
											m (ft)		
6.0 m (19.7 ft)	kg					*3,400	*3,400			*2,390	*2,390	5.50	
	lb					*7,500	*7,500			*5,270	*5,270	(18.0)	
4.5 m (14.8 ft)	kg					*3,700	*3,700	*3,500	2,950	*2,210	*2,210	6.44	
	lb					*8,160	*8,160	*7,720	6,500	*4,870	*4,870	(21.1)	
3.0 m (9.8 ft)	kg					*6,380	*6,380	*4,630	4,420	*4,000	2,880	6.93	
	lb					*14,070	*14,070	*10,210	9,740	*8,820	6,350	(22.7)	
1.5 m (4.9 ft)	kg					*7,050	*7,050	*5,760	4,170	*4,200	2,780	7.07	
	lb					*15,540	*15,540	*12,700	9,190	9,260	6,130	(23.2)	
Ground Line	kg					*6,550	*6,550	6,320	4,010	4,120	2,700	6.88	
	lb					*14,440	*14,440	13,930	8,840	9,080	5,950	(22.6)	
-1.5 m (-4.9 ft)	kg	*4,890	*4,890	*10,080	7,250	6,250	3,950		4,090	2,680	*3,160	2,500	6.34
	lb	*10,780	*10,780	*22,220	15,980	13,780	8,710		9,020	5,910	*6,970	5,510	(20.8)
-3.0 m (-9.8 ft)	kg	*9,020	*9,020	*8,820	7,370	*5,920	4,000				*4,580	3,210	5.31
	lb	*19,890	*19,890	*19,440	16,250	*13,050	8,820				*10,100	7,080	(17.4)

Boom : 4.6 m (15' 1") / Arm : 3.0 m (9' 10") / Shoe : 800 mm (32") triple grouser / Counter weight : 2,000 kg

Load point height m (ft)	Load radius								At max. reach				
	1.5 m (4.9 ft)		3.0 m (9.8 ft)		4.5 m (14.8 ft)		6.0 m (19.7 ft)		Capacity	Reach			
											m (ft)		
6.0 m (19.7 ft)	kg							*2,230	*2,230	*2,000	*2,000	6.08	
	lb							*4,920	*4,920	*4,410	*4,410	(20.0)	
4.5 m (14.8 ft)	kg							*3,280	2,990	*1,880	*1,880	6.94	
	lb							*7,230	6,590	*4,140	*4,140	(22.8)	
3.0 m (9.8 ft)	kg							*5,250	*5,250	*4,130	*4,130	7.40	
	lb							*11,570	*11,570	*9,110	*9,110	(24.3)	
1.5 m (4.9 ft)	kg							*8,390	7,730	*5,340	4,220	7.53	
	lb							*18,500	17,040	*11,770	9,300	(24.7)	
Ground Line	kg							*7,180	*7,180	*6,290	4,020	7.36	
	lb							*15,830	*15,830	*13,870	8,860	(24.1)	
-1.5 m (-4.9 ft)	kg	*4,370	*4,370	*9,280	7,200	6,220	3,920		4,050	2,640	*2,610	2,220	6.85
	lb	*9,630	*9,630	*20,460	15,870	13,710	8,640		8,930	5,820	*5,750	4,890	(22.5)
-3.0 m (-9.8 ft)	kg	*7,550	*7,550	*9,420	7,270	6,240	3,930				*3,560	2,730	5.91
	lb	*16,640	*16,640	*20,770	16,030	13,760	8,660				*7,850	6,020	(19.4)

- Lifting capacity are based on ISO 10567.
- Lifting capacity of the HX series does not exceed 75% of tipping load with the machine on firm, level ground or 87% of full hydraulic capacity.

- The Lift-point is bucket pivot mounting pin on the arm (without bucket mass).
- (*) indicates load limited by hydraulic capacity.

ENGINE	STD	OPT
Cummins QSF 3.8	●	
HYDRAULIC SYSTEM	STD	OPT
Intelligent Power Control (IPC)		
3-power mode, 2-work mode, user mode	●	
Variable power control	●	
Pump flow control	●	
Attachment mode flow control		●
Engine auto idle	●	
Engine auto shutdown control		●
CABIN & INTERIOR	STD	OPT
ISO Standard cabin		
Rise-up type windshield wiper	●	
Radio / USB player	●	
Handsfree mobile phone system with USB	●	
12 volt power outlet (24V DC to 12V DC converter)	●	
Electric horn	●	
All-weather steel cab with 360° visibility	●	
Safety glass windows	●	
Sliding fold-in front window	●	
Sliding side window (LH)	●	
Lockable door	●	
Hot & cool box	●	
Storage compartment & Ashtray	●	
Transparent cabin roof-cover	●	
Sun visor	●	
Door and cab locks, one key	●	
Mechanical suspension seat with heater	●	
Pilot-operated slidable joystick	●	
Console box height adjust system	●	
Automatic climate control		
Air conditioner & heater	●	
Defroster	●	
Starting aid (air grid heater) for cold weather	●	
Centralized monitoring		
8" LCD display	●	
Engine speed or trip meter/Accel.	●	
Engine coolant temperature gauge	●	
Max power	●	
Low speed/High speed	●	
Auto idle	●	
Overload	●	
Check Engine	●	
Air cleaner clogging	●	
Indicators	●	
ECO Gauges	●	
Fuel level gauge	●	
Hyd. oil temperature gauge	●	
Fuel warmer	●	
Warnings	●	
Communication error	●	
Low battery	●	
Clock	●	
Cabin lights		●
Cabin front window rain guard		●
Cabin roof-steel cover		●
Seat		
Adjustable air suspension seat with heater		●
Cabin FOPS/FOG		
FOPS (Falling Object Protective Structure) - ISO 3449 Level 2		●
FOG (Falling Object Guard)- Front & Top Guard		●
ISO/DIS 10262 Level 2 Top Guard		●
Cabin ROPS		
ROPS (Roll Over Protective Structure) - ISO 12117-2	●	

SAFETY	STD	OPT
Battery master switch	●	
Rearview camera	●	
AAVM (Advanced Around View Monitoring)		●
RH side view camera		●
Four front working lights (2 boom mounted, 2 front frame mounted)	●	
Travel alarm		●
Rear work lamp		●
Beacon lamp		●
Automatic swing brake	●	
Boom holding system	●	
Arm holding system	●	
Safety lock valve for boom cylinder with overload warning device		●
Safety lock valve for arm cylinder		●
Swing lock system		●
Two outside rearview mirrors	●	
OTHER	STD	OPT
Booms		
4.1 m; 13' 5" Mono-boom		●
4.6 m; 15' 1" Mono-boom	●	
4.9 m; 16' 9" 2-Piece boom		●
Arms		
1.9 m; 6' 3"		●
2.1 m; 6' 11"		●
2.5 m; 8' 2"	●	
3.0 m; 9' 10"		●
Removable clean-out dust net for cooler	●	
Removable reservoir tank	●	
Fuel pre-filter	●	
Fuel warmer		●
Self-diagnostics system	●	
Hi MATE (Remote Management System)	Mobile Satellite Dual	●
Batteries (2 x 12 V x 100 Ah)	●	
Fuel filler pump (50 l/min) with auto stop		●
Single-acting piping kit (breaker, etc.)		●
Double-acting piping kit (clamshell, etc.)	●	
Rotating Piping Kit		●
Quick coupler piping		●
Quick coupler		●
Boom floating control		●
Accumulator for lowering work equipment	●	
Pattern change valve (2 patterns)		●
Fine Swing Control System		●
Tool kit		●
UNDERCARRIAGE	STD	OPT
Lower frame under cover (Additional)		●
Lower frame under cover (Normal)	●	
Dozer blade		●
Track shoes		
Triple grouser shoes (600 mm; 24")	●	
Triple grouser shoes (700 mm; 28")		●
Triple grouser shoes (800 mm; 32")		●
Double grouser shoes (700 mm; 28")		●
Track rail guard	●	
Full track rail guard		●

STD = Standard
OPT = Optional

- * Standard and optional equipment may vary. Contact your Hyundai dealer for more information. The machine may vary according to International standards.
- * The photos may include attachments and optional equipment that are not available in your area.
- * Materials and specifications are subject to change without advance notice.
- * All imperial measurements rounded off to the nearest pound or inch.
- * The air condition system for the machine contains the fluorinated greenhouse gas with global warming potential of R134a. (Global Warming Potential : 1430) The system hold 0.65 kg refrigerant consisting of a CO₂ equivalent 0.93 kg metric tonne. For more information, Please refer to the manual.



PLEASE CONTACT

Hyundai Construction Equipment Europe nv

Hyundailaan 4, 3980 Tessenderlo, Belgium Tel: (32) 14-56-2200 Fax: (32) 14-59-3405 www.hyundai.eu

EN - 2018.09 Rev 0