

CRAWLER EXCAVATOR

HX220A1





READY TO CHANGE YOUR WORLD

The HX220AL Crawler Excavator is part of Hyundai's brand new A-series: a fresh generation of construction equipment that complies with the European stage V emission levels. But it does much more than that! While fulfilling regulatory demands, Hyundai aimed for a ground-breaking level of customer satisfaction with maximum performance and productivity, better safety, more convenience and improved uptime management.

From its robust exterior design to its smart performance-enhancing technologies, the HX220AL opens up a world of new possibilities where tiny efforts move mountains. It's time to experience the Hyundai Effect!

ENTER A WORLD WHERE ANYTHING IS POSSIBLE



Productivity

- Short cycle times
- Mono or two-piece boom
- Leading controllability with Electronic Pump Flow Control (EPFC)
- Customisable hydraulic attachment lines
- Attachment flow control (20 tools programmable)
- Fine swing control (option)
- Boom floating system (option)

Comfort

- Spacious cabin
- 8" touchscreen monitor
- Automatic climate control
- Smart key and start/stop button
- Air suspension seat with heater (option)
- Viscous cabin suspension mounts
- Ergonomic joystick design

Durability/Safety

- Excellent visibility
- AAVM camera system (option)
- LED lights (option)
- Reinforced upper and lower structure
- High-grade hoses
- Reinforced pins, bushings and polymer shims
- Swing lock (option)

Serviceability

- Excellent accessibility
- Electric Fuel Filter Pump with Automatic Stop Function
- Centralised greasing (option)
- Hi Mate telematic system
- Extended service intervals

POWERFUL AND FUEL-EFFICIENT TO BOOST PRODUCTIVITY

The HX220AL is powered by a robust Stage V-certified Cummins engine with an innovative integrated after-treatment system that reduces both emissions and maintenance requirements. It delivers all the power you need to handle demanding jobs, along with fast levelling and truck loading times and excellent fuel economy.

A range of smart technologies are included for precise management of the engine output and pump flow rate. A new EPFC (Electronic Pump Flow Control) system improves controllability and reduces operating costs. Additional control and monitoring features help you to further improve productivity every single day.

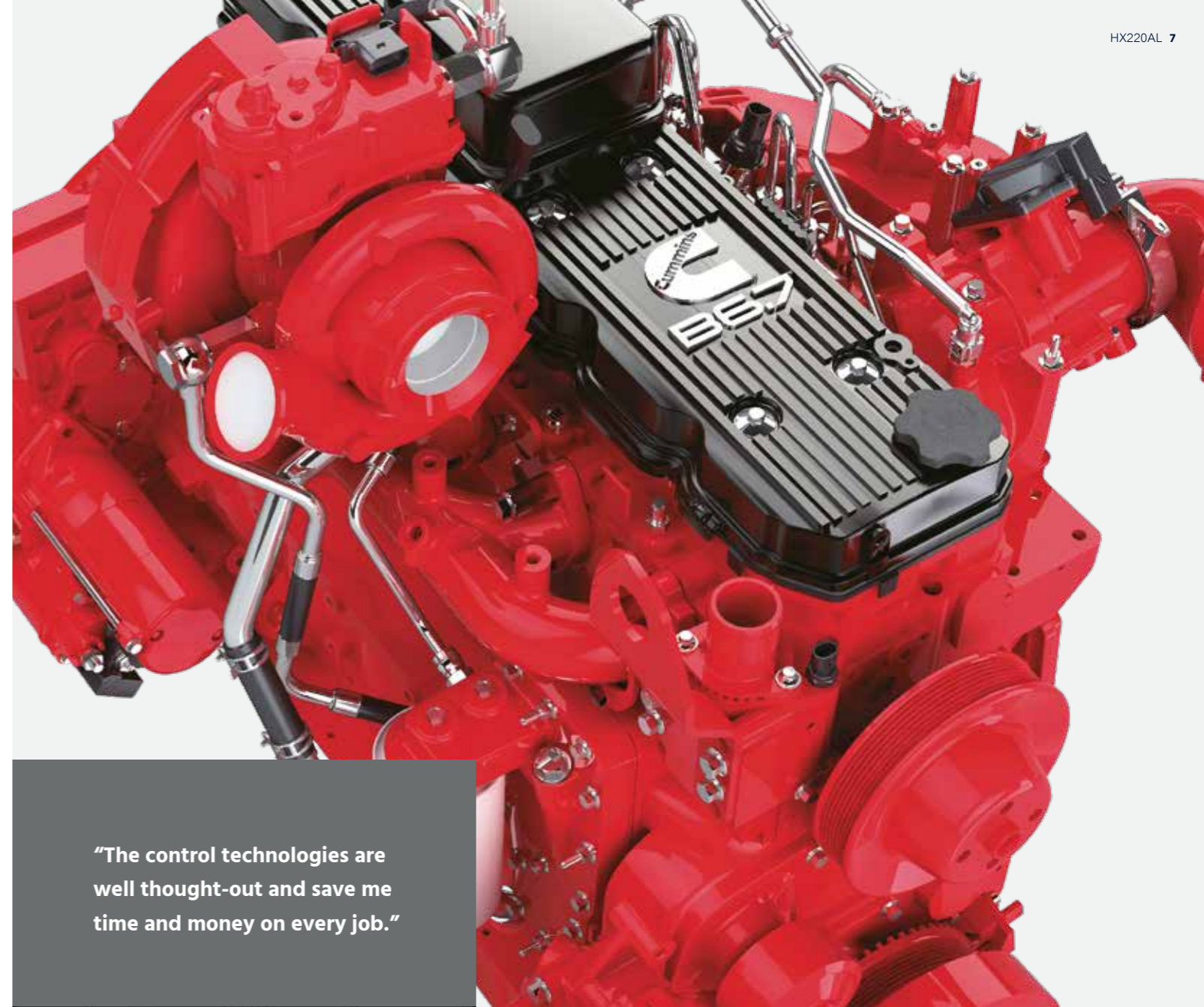

“The control technologies are well thought-out and save me time and money on every job.”

EPFC

Fuel Saving & Fine Control

EPFC (Electronic Pump Flow Control) improves the controllability of attachments, enabling faster, more precise work with optimised fine control. It also reduces fuel consumption by optimising pump output control for each operation.



Lifting mode improves precision and lift capability through RPM reduction, power boost activation and enhanced pump flow control.

The **combination speed setting system** allows operators to balance load sensitivity and boom priority against arm and swing. Select from five levels of load sensitivity to adjust initial flow rate for boom-up and arm-in operation according to attachment weight. Ten levels of boom priority can be selected to balance boom operation against arm and swing.

Like all A-Series machines, the HX220AL features our **all-in-one exhaust aftertreatment system** which cuts emissions and operating costs while enhancing reliability and simplifying maintenance.

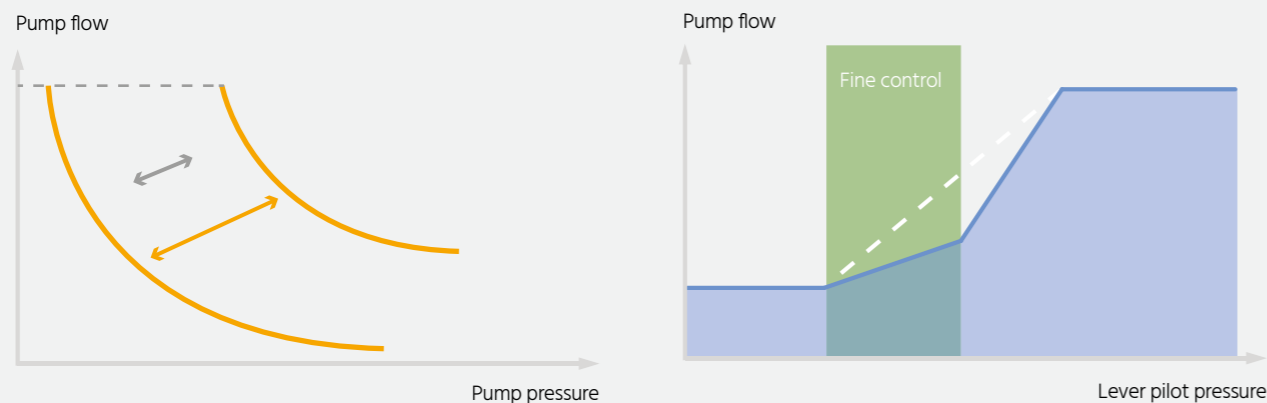

Easy-to-use **3D Machine Guidance** gives precise feedback on the bucket position as well as 3D grading assistance and jobsite mapping in real time. This reduces manpower requirements on site and enhances operator performance. The system includes an optional **Hyundai Ready automatic surveying system** for excavators which provides work guides to further improve work speed and productivity.

- Productivity Improvement
- Work Time Reduction
- Leveling Cost Reduction
- Safety Improvement

A CABIN DESIGNED AROUND YOU

The HX220AL cabin was designed as a comfortable working environment that enhances productivity and reduces fatigue for every operator. Pleasant and spacious, it features a high-quality, adjustable seat and comfortable reach to all controls. A range of technologies enable easier machine monitoring, while the audio system includes radio, USB and AUX input to keep you entertained during your working day. The overall design places you right at the centre of the Hyundai Effect, with a world of convenience and control at your fingertips.

"I can check the machine status anytime I want and adapt my performance for better, faster results. It's almost as if the machine has become an extension of me."



The accelerator, remote air conditioner controller and instrument cluster can be operated using the convenient jog shuttle-type **haptic controller**.



The **instrument panel** is optimised to provide quick, easy access to machine status information as you work. It features an 8-inch **touchscreen monitor** for excellent legibility.



The **Eco Report** feature helps you to develop efficient working habits by displaying real-time information about machine performance.

Menu functions can be set by the machine owner, who can also provide or restrict access for machine users by using a password to lock or unlock the list of machine parameters.



The HX220AL has a luxurious **air suspension seat with heating** as standard. The **ergonomic joysticks** make operation comfortable and intuitive.

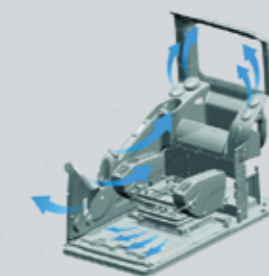

The **heating and air conditioning** system efficiently regulates and directs airflow in the cabin.



The **Miracast system based on the operator's smartphone Wi-Fi** allows the use of various smartphone features on the screen, including navigation, web surfing and music and video playback.

SUPPORTING A SAFER WORKPLACE

Small details can make a huge difference when it comes to safety and security. The HX220AL offers all-round protection for you, your workmates and your equipment. Its cabin and engine hood feature a new design that allows maximum visibility, while Advanced Around View Monitoring (AAVM) gives you a clear overview of your surroundings. By helping to ensure an accident-free worksite, the HX220AL contributes to the peace of mind and productivity that form part of the Hyundai Effect.

The **Advanced Around View Monitoring (AAVM)** camera system gives you a 360° overview of your immediate working environment. It also includes Intelligent Moving Object Detection (IMOD) technology that senses and warns you when people or objects come within five metres of the machine.

The **open design of the cabin side door** gives the operator a clear, unimpeded view to the exterior. The **door handle** design has also been redesigned for more convenient access.



"I can always see what's going on around me, even when weather conditions are poor or the machine is moving."



The **auto safety lock** feature prevents unintentional ignition. While the auto safety lock is activated, the excavator is not controlled by the RCV lever.

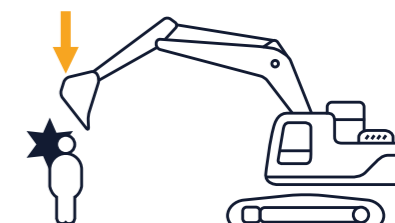
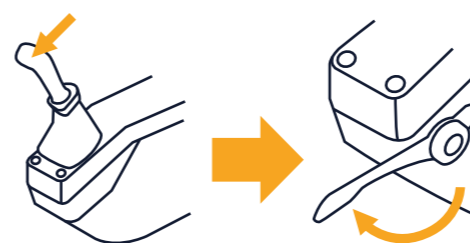

ADVANCED DIAGNOSTICS AND SERVICING SUPPORT

The peace of mind that comes with quick, low-effort servicing is also part of the Hyundai Effect. The HX220AL is designed to make maintenance as convenient as possible. All components and materials have been optimised to ensure a long, trouble-free life. Hyundai's Hi Mate remote management system uses mobile data technology to provide the highest level of service and support. The HX220AL also features our new Engine Connected Diagnostics (ECD) system which immediately reports any engine failure to both Hi Mate and the engine manufacturer to ensure the fastest, easiest resolution.

HiMATE



For maximum convenience and security, the HX220AL features Hyundai's exclusive Hi Mate remote fleet management system, which uses mobile data technology to provide the highest level of service and support. You can monitor your machines from any location via a dedicated website or mobile app, with access to working parameters like total engine hours, machine utilisation, actual performed working hours, fuel consumption and machine location. The system makes it easy to evaluate machine productivity, plan servicing and maintenance tasks, as well as any required cost saving measures. It also offers geofencing to protect your machines against theft and unauthorised usage.



"I have a constant overview of performance and maintenance requirements - plus advice and support whenever I need it."

ECD (Engine Connected Diagnostics) provides troubleshooting advice as well as tailored servicing and parts support from Cummins Quickservice. Service technicians are supported with remote diagnostics reports allowing them to prepare for site visits and bring the right tools.



READY FOR ACTION AND BUILT TO LAST

You need to know that the investment you make today will help to sustain your business over the long term. That's why we prioritised reliability throughout the development of the HX220AL, from design and manufacturing to quality control. We improved engine reliability by removing the EGR and integrating exhaust after treatment with a simplified, single-module system that's easier to maintain. The upper and lower frame structures are reinforced for high load work, while the attachments have been rigorously tested for the roughest conditions. The overall aim is to minimise downtime and repairs so that you can stay on schedule, avoid unexpected costs and protect your profits.



The engine and **exhaust after-treatment** system are integrated for simplified control and maintenance. ▶



◀ **High-grade hoses** with outstanding resistance to heat and pressure provide maximum durability, even in rough working conditions.



◀ The reinforced **pins, bushings and polymer shims** are designed for an extended lifetime.

FOCUSED TECHNOLOGIES FOR THE RESULTS YOU WANT

Hyundai's A-series crawler excavators are designed to create better conditions for operators and deliver the ultimate ownership experience. Every detail is carefully fine-tuned to match your needs in the field, including better safety and comfort, higher productivity, maximum uptime and easy servicing. It's all part of the Hyundai Effect.

See more at hyundai-ce.eu



SPECIFICATIONS

ENGINE	
Maker / Model	Cummins B6.7 / STAGE V
Type	Turbocharged, charge air cooled, diesel engine
Gross power (SAE J1995)	173 HP (129 kW) at 2,200 rpm
Net power (SAE J1349)	170 HP (127 kW) at 2,200 rpm
Max. Power	195 HP (145kW) at 2,000 rpm
Peak torque	881 N·m (650 lb ft) at 1,300 rpm
Displacement	6,700 cc (408 cu in)

HYDRAULIC SYSTEM	
MAIN PUMP	
Type	Variable displacement tandem axis piston pumps
Max. Flow	2 x 222 l/min
Sub-pump for pilot circuit	Gear pump
Cross-sensing and fuel saving pump system	
HYDRAULIC MOTORS	
Travel	Two speed axial pistons motor with brake valve and parking brake
Swing	Axial piston motor with automatic brake
RELIEF VALVE SETTING	
Implement circuits	350 kgf/cm ² (4,980 psi)
Travel	350 kgf/cm ² (4,980 psi)
Power Boost (boom, arm, bucket)	380 kgf/cm ² (5,400 psi)
Swing circuit	265 kgf/cm ² (3,770 psi)
Pilot circuit	40 kgf/cm ² (570 psi)
Service valve	Installed
HYDRAULIC CYLINDERS	
No. of cylinder bore X stroke	Boom: Ø 120 x 1,290 mm
	Arm: Ø 140 x 1,510 mm
	Bucket: Ø 120 x 1,055 mm

* Hyundai Bio Hydraulic Oil (HBHO) available.

DRIVING AND BRAKING	
Drive method	Fully hydrostatic type
Driving Motor	Axial piston motor, in-shoe design
Deceleration System	Planetary reduction gear
Max. Drawbar Pull	20,800 kgf (45,860 lbf)
Max. travel speed (high / low)	5.4 km/hr (3.4 mph) / 3.5 km/hr (2.2 mph)
Gradeability	35° (70%)
Parking brake	Multi wet disc

CONTROL	
Pilot pressure operated joysticks and pedals with detachable lever provide almost effortless and fatigueless operation.	
Pilot control	Two joysticks with one safety lever (LH): Swing and arm, Boom and bucket
Traveling and steering	Two levers with pedals
Engine throttle	Electric, Dial type

SWING SYSTEM	
Swing motor	Fixed displacement axial piston motor
Swing reduction	Planetary gear reduction
Swing bearing lubrication	Grease-bathed
Swing brake	Multi wet disc
Swing speed	11.4 rpm

CAPACITIES			
	liter	US gal	UK gal
Fuel tank	400	106	88
Engine coolant	40	10.6	8.8
Engine oil	23.1	6.1	5.1
Swing device	6.2	1.64	1.36
Final Drive (each)	4.5	1.2	1
Hydraulic system (including tank)	275	72.6	60.5
Hydraulic tank	155	40.9	34.1
DEF/AdBlue®	48	12.6	10.5

UNDERCARRIAGE	
The X-leg type center frame is integrally welded with reinforced box-section track frames. The undercarriage includes lubricated rollers, idlers, track adjusters with shock absorbing springs and sprockets, and a track chain with double or triple grouser shoes.	
Center frame	X - leg type
Track frame	Pentagonal box type
No. of shoes on each side	49 EA
No. of carrier roller on each side	2 EA
No. of track roller on each side	9 EA
No. of rail guard on each side	2 EA

OPERATING WEIGHT (APPROXIMATE)	
Operating weight, including 5,680 mm (18' 8") boom, 2,920 mm (9' 7") arm, SAE heaped 0.92 m ³ (1.20 yd ³) bucket, lubricant, coolant, full fuel tank, full hydraulic tank, and all standard equipments.	

OPERATING WEIGHT				
Shoes		Operating weight		Ground pressure
Type	Width mm (in)		kg (lb)	kgf/cm ² (psi)
Triple grouser	600 (24")	HX220AL	22,100 (48,720)	0.47 (6.71)
		HX220ALHW	23,560 (51,940)	0.50 (7.15)
	700 (28")	HX220AL	22,380 (49,340)	0.41 (5.82)
		HX220ALHW	23,840 (52,560)	0.44 (6.20)
	800 (32")	HX220AL	22,660 (49,960)	0.36 (5.16)
		HX220ALHW	24,120 (53,170)	0.39 (5.49)
900 (36")	HX220AL	22,940 (50,570)	0.33 (4.64)	
	HX220ALHW	24,400 (53,790)	0.35 (4.94)	
Double grouser	700 (28")	HX220ALHW	24,040 (53,000)	0.44 (6.25)

AIR CONDITIONING SYSTEM	
The air conditioning system contains fluorinated greenhouse gas refrigerant R134a (Global Warming Potential = 1,430). The system contains 0.80 kg of refrigerant representing a CO ₂ equivalent of 1.14 metric tonnes.	

DIMENSIONS & WORKING RANGE

HX220AL DIMENSIONS

5.68 m (18' 8") BOOM and 2.0 m (6' 7"); 2.4 m (7' 10"); 2.92 m (9' 7") & 3.9 m (12' 10") ARM

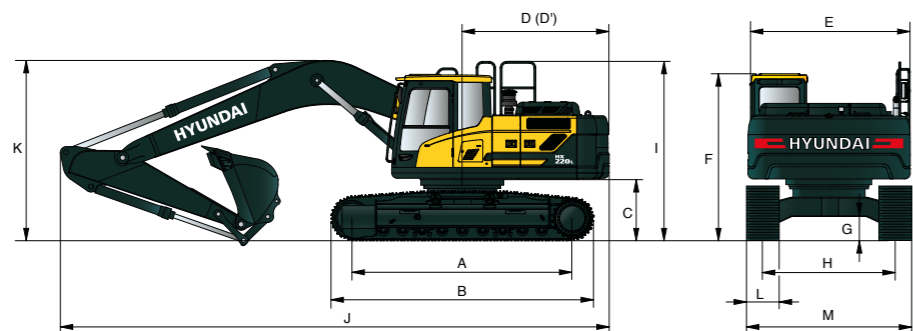

Unit : mm (ft in)

A	Tumbler distance	3,650 (12' 0")
B	Overall length of crawler	4,404 (14' 4")
C	Ground clearance of counterweight	1,060 (3' 6")
D	Tail swing radius	2,890 (9' 5")
D'	Rear-end length	2,770 (9' 1")
E	Overall width of upperstructure	2,740 (9' 0")
F	Overall height of cabin	3,000 (9' 8")
G	Min. ground clearance	470 (1' 7")
H	Track gauge	2,390 (7' 10")
I	Overall height of guardrail	3,210 (10' 5")

Boom length	5,680 (18' 8")			
Arm length	2,000 (6' 7")	2,400 (7' 10")	2,920 (9' 7")	3,900 (12' 10")
J Overall length	9,650 (31' 8")	9,570 (31' 5")	9,530 (31' 3")	9,520 (31' 3")
K Overall height of boom	3,200 (10' 6")	3,110 (10' 2")	3,030 (9' 11")	3,480 (11' 5")
L Track shoe width	600 (24")	700 (28")	800 (32")	900 (36")
M Overall width	2,990 (9' 10")	3,090 (10' 2")	3,190 (10' 6")	3,290 (10' 10")

* This figure includes the size of grouser.

HX220AL WORKING RANGE

Unit : mm (ft in)

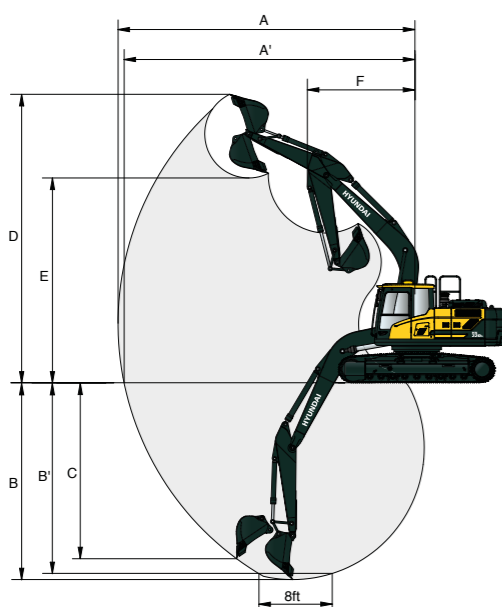

Boom length	5,680 (18' 8")			
Arm length	2,000 (6' 7")	2,400 (7' 10")	2,920 (9' 7")	3,900 (12' 10")
A Max. digging reach	9,140 (30' 0")	9,500 (31' 2")	9,980 (32' 9")	10,910 (35' 10")
A' Max. digging reach on ground	8,960 (29' 5")	9,330 (30' 7")	9,820 (32' 3")	10,770 (35' 4")
B Max. digging depth	5,820 (19' 1")	6,220 (20' 5")	6,730 (22' 1")	7,720 (25' 4")
B' Max. digging depth (8' level)	5,580 (18' 4")	6,010 (19' 9")	6,560 (21' 6")	7,580 (24' 10")
C Max. vertical wall digging depth	5,280 (17' 4")	5,720 (18' 9")	6,280 (20' 7")	7,240 (23' 9")
D Max. digging height	9,140 (30' 0")	9,340 (30' 8")	9,600 (31' 6")	10,110 (33' 2")
E Max. dumping height	6,330 (20' 9")	6,520 (21' 5")	6,780 (22' 3")	7,290 (23' 11")
F Min. front swing radius	3,750 (12' 4")	3,740 (12' 3")	3,670 (12' 0")	3,700 (12' 2")

DIMENSIONS & WORKING RANGE

HX220AL 2-PIECE BOOM DIMENSIONS

5.65 m (18' 6") 2-Piece BOOM and 2.0 m (6' 7"); 2.4 m (7' 10") & 2.92 m (9' 7") ARM

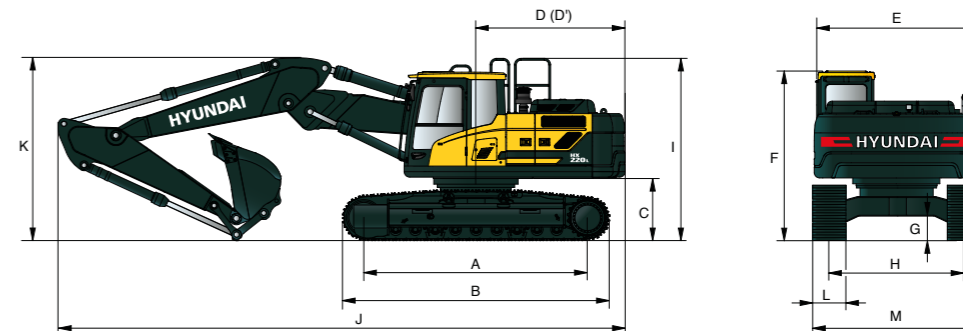

Unit : mm (ft in)

A	Tumbler distance	3,650 (12' 0")
B	Overall length of crawler	4,404 (14' 4")
C	Ground clearance of counterweight	1,060 (3' 6")
D	Tail swing radius	2,890 (9' 5")
D'	Rear-end length	2,770 (9' 1")
E	Overall width of upperstructure	2,740 (9' 0")
F	Overall height of cabin	3,000 (9' 8")
G	Min. ground clearance	470 (1' 7")
H	Track gauge	2,390 (7' 10")
I	Overall height of guardrail	3,210 (10' 5")

Boom length	5,650 (18' 6") 2-Piece Boom			
Arm length	2,000 (6' 7")	2,400 (7' 10")	2,920 (9' 7")	
J Overall length	9,650 (31' 8")	9,570 (31' 5")	9,530 (31' 3")	
K Overall height of boom	3,200 (10' 6")	3,110 (10' 2")	3,030 (9' 11")	
L Track shoe width	600 (24")	700 (28")	800 (32")	900 (36")
M Overall width	2,990 (9' 10")	3,090 (10' 2")	3,190 (10' 6")	3,290 (10' 10")

* This figure includes the size of grouser.

HX220AL 2-PIECE BOOM WORKING RANGE

Unit : mm (ft in)

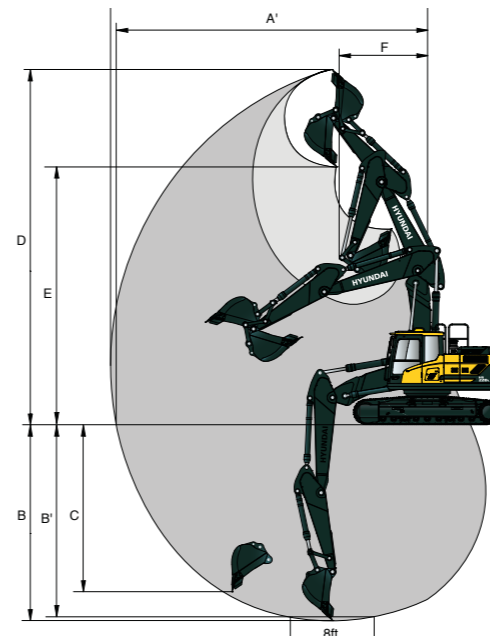

Boom length	5,650 (18' 6") 2-Piece Boom		
Arm length	2,000 (6' 7")	2,400 (7' 10")	2,920 (9' 7")
A Max. digging reach	9,120 (29' 11")	9,530 (31' 3")	10,020 (32' 10")
A' Max. digging reach on ground	8,950 (29' 4")	9,360 (30' 8")	9,860 (32' 4")
B Max. digging depth	5,480 (18' 0")	5,880 (19' 3")	6,400 (21' 0")
B' Max. digging depth (8' level)	5,360 (17' 7")	5,770 (18' 11")	6,290 (20' 8")
C Max. vertical wall digging depth	4,540 (14' 11")	5,020 (16' 6")	5,560 (18' 3")
D Max. digging height	10,310 (33' 10")	10,670 (35' 0")	11,090 (36' 5")
E Max. dumping height	7,390 (24' 3")	7,750 (25' 5")	8,160 (26' 9")
F Min. front swing radius	2,870 (9' 5")	2,660 (8' 9")	2,530 (8' 4")

DIMENSIONS & WORKING RANGE

HX220AL LONG REACH DIMENSIONS

8.2 m (26' 11") BOOM and 6.3 m (20' 8") ARM

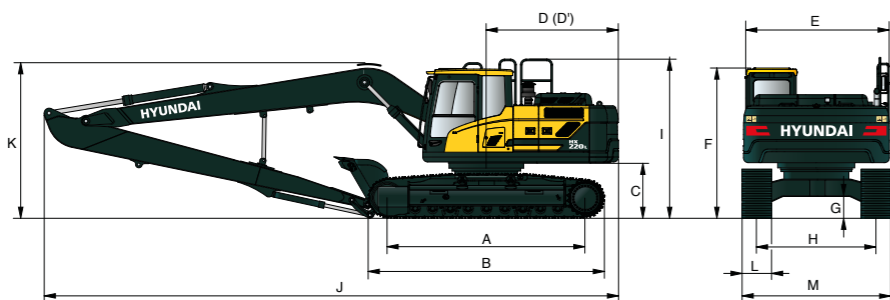

Unit : mm (ft in)

A	Tumbler distance	3,650 (12' 0")
B	Overall length of crawler	4,404 (14' 4")
C	Ground clearance of counterweight	1,060 (3' 6")
D	Tail swing radius	2,890 (9' 5")
D'	Rear-end length	2,770 (9' 1")
E	Overall width of upperstructure	2,740 (9' 0")
F	Overall height of cabin	3,000 (9' 8")
G	Min. ground clearance	470 (1' 7")
H	Track gauge	2,390 (7' 10")
I	Overall height of guardrail	3,210 (10' 5")

Boom length	8,200 (26' 11")	
Arm length	6,300 (20' 8")	
J	Overall length	12,030 (39' 6")
K	Overall height of boom	3,280 (10' 9")
L	Track shoe width	800 (32")
M	Overall width	3,190 (10' 6")

DIMENSIONS & WORKING RANGE

HX220AL HIGH WALKER DIMENSIONS

5.68 m (18' 8") BOOM and 2.0 m (6' 7"); 2.4 m (7' 10") & 2.92 m (9' 7") ARM

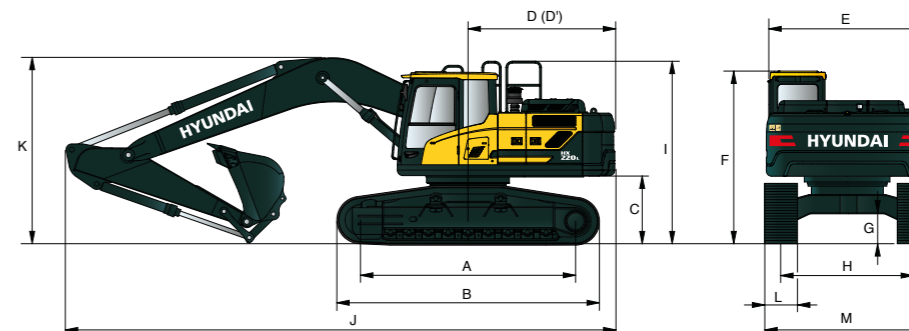

Unit : mm (ft in)

A	Tumbler distance	3,650 (12' 0")
B	Overall length of crawler	4,404 (14' 4")
C	Ground clearance of counterweight	1,260 (4' 1")
D	Tail swing radius	2,890 (9' 5")
D'	Rear-end length	2,770 (9' 1")
E	Overall width of upperstructure	2,740 (9' 0")
F	Overall height of cabin	3,200 (10' 5")
G	Min. ground clearance	660 (2' 2")
H	Track gauge	2,795 (9' 2")
I	Overall height of guardrail	3,410 (11' 2")

Boom length	5,680 (18' 8")					
Arm length	2,000 (6' 7")	2,400 (7' 10")	2,920 (9' 7")	3,900 (12' 10")		
J	Overall length	9,650 (31' 8")	9,550 (31' 4")	9,470 (31' 1")	9,560 (31' 4")	
K	Overall height of boom	3,290 (10' 10")	3,170 (10' 5")	3,060 (10' 0")	3,450 (11' 4")	
L	Track shoe width	Triple grouser				Double grouser
		Width	600 (24")	700 (28")	800 (32")	900 (36")
M	Overall width	3,395 (11' 2")	3,495 (11' 6")	3,595 (11' 10")	3,695 (12' 2")	3,495 (11' 6")

HX220AL LONG REACH WORKING RANGE

Unit : mm (ft in)

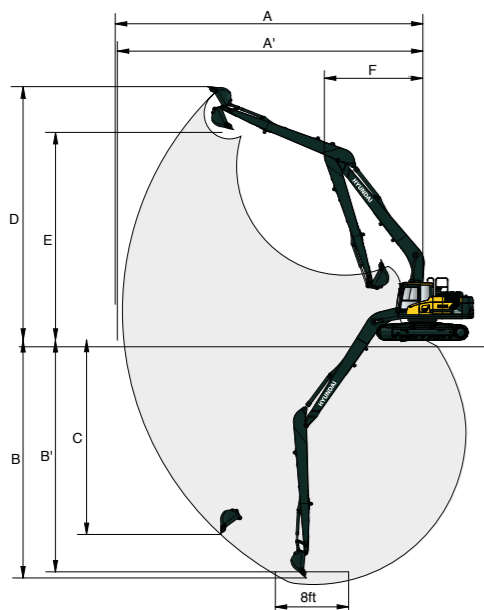

Boom length	8,200 (26' 11")	
Arm length	6,300 (20' 8")	
A	Max. digging reach	15,220 (50' 0")
A'	Max. digging reach on ground	15,120 (49' 7")
B	Max. digging depth	11,760 (38' 7")
B'	Max. digging depth (8' level)	11,650 (38' 3")
C	Max. vertical wall digging depth	9,610 (31' 6")
D	Max. digging height	12,550 (41' 2")
E	Max. dumping height	10,280 (33' 8")
F	Min. front swing radius	4,870 (16' 0")

HX220AL HIGH WALKER WORKING RANGE

Unit : mm (ft in)

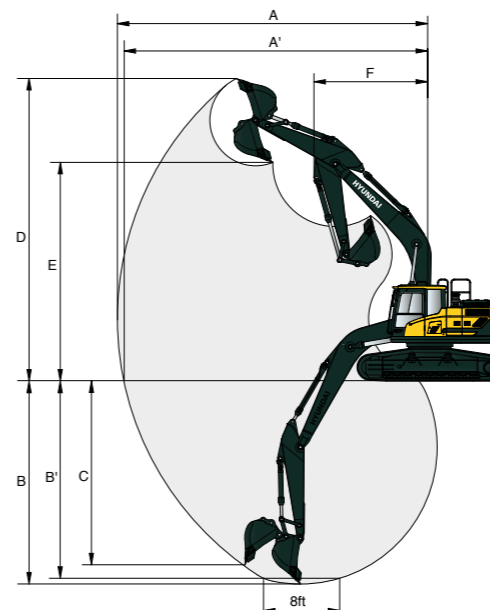

Boom length	5,680 (18' 8")				
Arm length	2,000 (6' 7")	2,400 (7' 10")	2,920 (9' 7")	3,900 (12' 10")	
A	Max. digging reach	9,140 (30' 0")	9,500 (31' 2")	9,980 (32' 9")	10,910 (35' 10")
A'	Max. digging reach on ground	8,920 (29' 3")	9,290 (30' 6")	9,820 (32' 3")	10,730 (35' 2")
B	Max. digging depth	5,630 (18' 6")	6,010 (19' 9")	6,550 (21' 6")	7,530 (24' 8")
B'	Max. digging depth (8' level)	5,390 (17' 8")	5,820 (19' 1")	6,380 (20' 11")	7,390 (24' 3")
C	Max. vertical wall digging depth	5,090 (16' 8")	5,630 (18' 6")	6,100 (20' 0")	7,050 (23' 1")
D	Max. digging height	9,330 (30' 7")	9,530 (31' 3")	9,780 (32' 1")	10,300 (33' 9")
E	Max. dumping height	6,520 (21' 5")	6,710 (22' 0")	6,960 (22' 10")	7,480 (24' 6")
F	Min. front swing radius	3,750 (12' 4")	3,740 (12' 3")	3,670 (12' 0")	3,700 (12' 2")

BUCKET SELECTION GUIDE & DIGGING FORCE

BUCKETS

All buckets are welded with high-strength steel.



SAE heaped m³ (yd³)	0.80 (1.05)	1.34 (1.75)	◆ 0.90 (1.18)	◆ 0.87 (1.14)	◆ 1.20 (1.57)	★ 0.52 (0.68)
	0.92 (1.20)		◆ 1.05 (1.37)			
	1.10 (1.44)					
	1.20 (1.57)					

Capacity m³ (yd³)			Width mm (in)	Weight kg (lb)	Tooth (EA)	Recommendation mm (ft.in)								
SAE heaped	CECE heaped	Without side cutters	5,680 (18' 8") Mono boom					8,200 (26' 11") Long reach	5,650 (18' 6") 2-piece boom					
			2,000 (6' 7") Arm	2,400 (7' 10") Arm	2,920 (9' 7") Arm	3,900 (12' 10") Arm	6,300 (20' 8") Arm	2,000 (6' 7") Arm	2,400 (7' 10") Arm	2,920 (9' 7") Arm				
0.80 (1.05)	0.70 (0.92)	1,070 (42.1)	770 (1,700)	5	●	●	●	●	-	●	●	●	●	
0.92 (1.20)	0.80 (1.05)	1,190 (46.9)	820 (1,810)	5	●	●	●	●	-	●	●	●	●	
1.10 (1.44)	0.96 (1.26)	1,375 (54.1)	890 (1,960)	5	●	●	●	▲	-	●	●	●	■	
1.20 (1.57)	1.05 (1.37)	1,390 (54.7)	920 (2,030)	5	●	●	■	▲	-	●	●	●	■	
1.34 (1.75)	1.17 (1.53)	1,525 (60.0)	990 (2,180)	6	●	■	▲	x	-	●	■	▲	▲	
◆ 0.90 (1.18)	0.79 (1.03)	1,210 (47.6)	880 (1,940)	5	●	●	●	■	-	●	●	●	●	
◆ 1.05 (1.37)	0.92 (1.20)	1,355 (53.3)	940 (2,070)	5	●	●	●	▲	-	●	●	●	●	
◆ 0.87 (1.14)	0.77 (1.01)	1,195 (47.0)	940 (2,070)	5	●	●	●	-	-	●	●	●	●	
◆ 1.20 (1.57)	1.05 (1.37)	1,520 (59.8)	1,120 (2,470)	6	●	●	■	-	-	●	■	■	■	
★ 0.52 (0.68)	0.45 (0.59)	945 (37.2)	460 (1,010)	5	-	-	-	-	-	-	-	-	-	

- ◆ Heavy duty bucket
- ◆ Rock-Heavy duty bucket
- ★ Long reach bucket
- Applicable for materials with density of 2100kg/m³ (3500 lb/yd³) or less
- Applicable for materials with density of 1800kg/m³ (3000 lb/yd³) or less
- Applicable for materials with density of 1500kg/m³ (2500 lb/yd³) or less
- ▲ Applicable for materials with density of 1200kg/m³ (2000 lb/yd³) or less
- x Not recommended

ATTACHMENT

Booms and arms are welded with a low-stress, full-box section design.
5.68 m, 8.2 m Booms and 2.0 m, 2.4 m, 2.92 m, 3.9 m & 6.3 m Arms are available.

DIGGING FORCE

Boom	Length	mm (ft.in)	5,680 (18' 8")				5,650 (18' 6") 2-Piece			8,200 (26' 11")	Remark
			Weight	kg (lb)							
Arm	Length	mm (ft.in)	2,000 (6' 7")	2,400 (7' 10")	2,920 (9' 7")	3,900 (12' 10")	2,000 (6' 7")	2,400 (7' 10")	2,920 (9' 7")	6,300 (20' 8")	
	Weight	kg (lb)	975 (2,150)	1,045 (2,300)	1,095 (2,410)	1,295 (2,850)	975 (2,150)	1,045 (2,300)	1,095 (2,410)	1,330 (2,930)	
Bucket digging force	SAE	kN	133.4 [144.8]				133.4 [144.8]			72.6	[] : Power Boost
		kgf	13,600 [14,770]				13,600 [14,770]			7,400	
	lbf	29,980 [32,550]				29,980 [32,550]			16,310		
	ISO	kN	152.0 [165.0]				152.0 [165.0]			83.4	
Arm crowd force	SAE	kN	144.2 [156.5]	119.6 [129.9]	102.0 [110.7]	84.3 [91.6]	144.2 [156.5]	119.6 [129.9]	102.0 [110.7]	49.0	
		kgf	14,700 [15,960]	12,200 [13,250]	10,400 [11,290]	8,600 [9,340]	14,700 [15,960]	12,200 [13,250]	10,400 [11,290]	5,000	
	lbf	32,410 [35,190]	26,900 [29,210]	22,930 [24,900]	18,960 [20,590]	32,410 [35,190]	26,900 [29,210]	22,930 [24,900]	11,020		
	ISO	kN	151.0 [164.0]	125.5 [136.3]	106.9 [116.1]	87.3 [94.8]	151.0 [164.0]	125.5 [136.3]	106.9 [116.1]	50.0	
	ISO	kgf	15,400 [16,720]	12,800 [13,900]	10,900 [11,830]	8,900 [9,660]	15,400 [16,720]	12,800 [13,900]	10,900 [11,830]	5,100	
		lbf	33,950 [36,860]	28,220 [30,640]	24,030 [26,090]	19,620 [21,300]	33,950 [36,860]	28,220 [30,640]	24,030 [26,090]	11,240	

Note: Boom weight includes arm cylinder, piping, and pin
Arm weight includes bucket cylinder, linkage, and pin

LIFTING CAPACITY

Rating over-front Rating over-side or 360 degrees

HX220AL

5.68 m (18' 8") Mono boom, 2.00 m (6' 7") arm equipped with 600 mm (24") triple grouser shoe.



Lift-point height m (ft)	Lift-point radius								At max. Reach		
	3.0 m (9.8 ft)		4.5 m (14.8 ft)		6.0 m (19.7 ft)		7.5 m (24.6 ft)		Capacity	Reach	
											m (ft)
7.5 m (24.6 ft)									*5,720	*5,720	5.00
6.0 m (19.7 ft)									*12,610	*12,610	(16.4)
kg									*5,460	5,440	6.35
lb									*12,040	11,990	(20.8)
4.5 m (14.8 ft)									*6,900	*6,900	7.14
kg									*5,810	5,310	(23.4)
lb									*15,210	11,710	
3.0 m (9.8 ft)									*6,540	5,090	7.55
kg									*8,690	7,640	(24.8)
lb									*19,160	16,840	
1.5 m (4.9 ft)									*7,270	4,880	7.64
kg									*16,030	10,760	(25.1)
lb									7,580	4,760	
Ground Line									*10,520	7,090	7.43
kg									*23,190	15,630	(24.4)
lb									16,710	10,490	
-1.5 m (-4.9 ft)									*10,220	7,100	6.88
kg									*22,530	15,650	(22.6)
lb									6,230	3,980	
-3.0 m (-9.8 ft)									*12,370	*12,370	5.90
kg									*27,270	*27,270	(19.4)
lb									*20,130	15,960	
-4.5 m (-14.8 ft)											

5.68 m (18' 8") Mono boom, 2.40 m (7' 10") arm equipped with 600 mm (24") triple grouser shoe.

Lift-point height m (ft)	Lift-point radius								At max. Reach		
	3.0 m (9.8 ft)		4.5 m (14.8 ft)		6.0 m (19.7 ft)		7.5 m (24.6 ft)		Capacity	Reach	
											m (ft)
7.5 m (24.6 ft)									*5,080	*5,080	5.58
6.0 m (19.7 ft)									*11,200	*11,200	(18.3)
kg									*5,010	*5,010	6.82
lb									*11,050	*11,050	(22.4)
4.5 m (14.8 ft)									*6,350	*6,350	7.55
kg									*5,450	5,340	(24.8)
lb									*14,000	*14,000	
3.0 m (9.8 ft)									*6,230	5,110	7.94
kg									*8,150	7,740	(26.1)
lb									*17,970	17,060	
1.5 m (4.9 ft)									*7,030	4,880	8.03
kg									*9,710	7,270	(26.3)
lb									*21,410	16,030	
Ground Line									*10,410	7,060	7.83
kg									*22,950	15,560	(25.7)
lb									16,640	10,430	
-1.5 m (-4.9 ft)									*10,830	*10,830	7.31
kg									*10,330	7,040	(24.0)
lb									*23,880	*23,880	
-3.0 m (-9.8 ft)									*9,490	7,140	6.40
kg									*13,260	*13,260	(21.0)
lb									*29,230	*29,230	
-4.5 m (-14.8 ft)									*7,150	*7,150	4.89
kg									*15,760	*15,760	(16.0)
lb											













- Lifting capacity is based on ISO 10567.
- Lifting capacity of HX A Series does not exceed 75% of tipping load with the machine on firm, level ground or 87% of full hydraulic capacity.
- The Lift-point is bucket pivot mounting pin on the arm (without bucket mass).
- (*) indicates load limited by hydraulic capacity.
- Caution: please be aware of the local regulations and instructions for lifting operations.

LIFTING CAPACITY















Rating over-front  Rating over-side or 360 degrees 

HX220AL

5.68 m (18' 8") Mono boom, 2.92 m (9' 7") arm equipped with 800 mm triple grouser shoe.



Lift-point height m (ft)	Lift-point radius										At max. Reach			
	1.5 m (4.9 ft)		3.0 m (9.8 ft)		4.5 m (14.8 ft)		6.0 m (19.7 ft)		7.5 m (24.6 ft)		Capacity	Reach		
													m (ft)	
7.5 m (24.6 ft)	kg											*3,370	*3,370	6.26
	lb											*7,430	*7,430	(20.5)
6.0 m (19.7 ft)	kg											*3,100	*3,100	7.38
	lb											*6,830	*6,830	(24.2)
4.5 m (14.8 ft)	kg											*4,970	*4,970	8.07
	lb											*10,960	*10,960	(26.5)
3.0 m (9.8 ft)	kg					*7,410	*7,410					*5,800	5,300	8.43
	lb					*16,340	*16,340	*12,790	11,680	*11,180	8,360	*6,770	*6,770	(27.7)
1.5 m (4.9 ft)	kg					*9,140	7,570	*6,680	5,040	*5,520	3,670	*3,250	3,040	8.51
	lb					*20,150	16,690	*14,730	11,110	*12,170	8,090	*7,170	6,700	(27.9)
Ground Line	kg					*5,930	*5,930	*10,140	7,270	*7,330	4,860	5,600	3,570	8.32
	lb					*13,070	*13,070	*22,350	16,030	*16,160	10,710	12,350	7,870	(27.3)
-1.5 m (-4.9 ft)	kg	*6,500	*6,500	*10,400	*10,400	*10,350	7,180	*7,590	4,780	5,560	3,540	*4,200	3,350	7.84
	lb	*14,330	*14,330	*22,930	*22,930	*22,820	15,830	*16,730	10,540	12,260	7,800	*9,260	7,390	(25.7)
-3.0 m (-9.8 ft)	kg	*11,120	*11,120	*14,180	14,090	*9,820	7,240	*7,250	4,810			*5,420	3,940	7.00
	lb	*24,520	*24,520	*31,260	31,060	*21,650	15,960	*15,980	10,600			*11,950	8,690	(23.0)
-4.5 m (-14.8 ft)	kg			*11,610	*11,610	*8,190	7,450					*6,080	5,420	5.65
	lb			*25,600	*25,600	*18,060	16,420					*13,400	11,950	(18.5)

5.68 m (18' 8") Mono boom, 3.90 m (12' 9") arm equipped with 600 mm (24") triple grouser shoe.

Lift-point height m (ft)	Lift-point radius										At max. Reach				
	1.5 m (4.9 ft)		3.0 m (9.8 ft)		4.5 m (14.8 ft)		6.0 m (19.7 ft)		7.5 m (24.6 ft)		9.0 m (29.5 ft)		Capacity	Reach	
															m (ft)
7.5 m (24.6 ft)	kg												*2,330	*2,330	7.49
	lb												*5,140	*5,140	(24.6)
6.0 m (19.7 ft)	kg												*3,680	*3,680	8.44
	lb												*8,110	*8,110	(27.7)
4.5 m (14.8 ft)	kg												*3,920	3,820	9.05
	lb												*8,640	8,420	(29.7)
3.0 m (9.8 ft)	kg												*5,890	*5,890	9.37
	lb												*12,990	*12,990	(30.7)
1.5 m (4.9 ft)	kg												*8,630	*8,630	9.45
	lb												*19,030	*19,030	(31.0)
Ground Line	kg												*7,210	*7,210	9.28
	lb												*15,900	*15,900	(30.4)
-1.5 m (-4.9 ft)	kg	*5,430	*5,430	*9,370	*9,370	*10,030	6,770	*7,260	4,480	5,240	3,280		*2,780	2,610	8.85
	lb	*11,970	*11,970	*20,660	*20,660	*22,110	14,930	*16,010	9,880	11,550	7,230		*6,130	5,750	(29.0)
-3.0 m (-9.8 ft)	kg	*8,510	*8,510	*13,040	*13,040	*10,030	6,730	7,250	4,440	5,220	3,270		*3,380	2,950	8.12
	lb	*18,760	*18,760	*28,750	*28,750	*22,110	14,840	15,980	9,790	11,510	7,210		*7,450	6,500	(26.6)
-4.5 m (-14.8 ft)	kg	*12,380	*12,380	*13,530	13,400	*9,220	6,840	*6,720	4,520				*4,660	3,700	6.99
	lb	*27,290	*27,290	*29,830	29,540	*20,330	15,080	*14,820	9,960				*10,270	8,160	(22.9)
-6.0 m (-19.7 ft)	kg			*10,120	*10,120	*6,860	*6,860						*5,510	*5,510	5.21
	lb			*22,310	*22,310	*15,120	*15,120						*12,150	*12,150	(17.1)













- Lifting capacity is based on ISO 10567.
- Lifting capacity of HX A Series does not exceed 75% of tipping load with the machine on firm, level ground or 87% of full hydraulic capacity.
- The Lift-point is bucket pivot mounting pin on the arm (without bucket mass).
- (*) indicates load limited by hydraulic capacity.
- Caution: please be aware of the local regulations and instructions for lifting operations.

LIFTING CAPACITY















Rating over-front  Rating over-side or 360 degrees 

HX220AL

5.68 m (18' 8") Mono boom, 2.92 m (9' 7") arm equipped with 600 mm (24") triple grouser shoe.

Lift-point height m (ft)	Lift-point radius										At max. Reach				
	1.5 m (4.9 ft)		3.0 m (9.8 ft)		4.5 m (14.8 ft)		6.0 m (19.7 ft)		7.5 m (24.6 ft)		Capacity	Reach			
													m (ft)		
7.5 m (24.6 ft)	kg												*4,460	*4,460	6.26
	lb												*9,830	*9,830	(20.5)
6.0 m (19.7 ft)	kg												*4,460	*4,460	7.38
	lb												*9,830	*9,830	(24.2)
4.5 m (14.8 ft)	kg												*4,970	*4,970	8.07
	lb												*10,960	*10,960	(26.5)
3.0 m (9.8 ft)	kg												*7,410	*7,410	8.43
	lb												*16,340	*16,340	(27.7)
1.5 m (4.9 ft)	kg												*9,140	7,340	8.51
	lb												*20,150	16,180	(27.9)
Ground Line	kg												*5,930	*5,930	8.32
	lb												*13,070	*13,070	(27.3)
-1.5 m (-4.9 ft)	kg	*6,500	*6,500	*10,400	*10,400	*10,350	6,950	*7,440	4,620	5,380	3,420	*4,200	3,230	7.84	
	lb	*14,330	*14,330	*22,930	*22,930	*22,820	15,320	*16,400	10,190	11,860	7,540	*9,260	7,120	(25.7)	
-3.0 m (-9.8 ft)	kg	*11,120	*11,120	*14,180	13,660	*9,820	7,010	*7,250	4,650			*5,420	3,800	7.00	
	lb	*24,520	*24,520	*31,260	30,120	*21,650	15,450	*15,980	10,250			*11,950	8,380	(23.0)	
-4.5 m (-14.8 ft)	kg												*11,610	*11,610	5.65
	lb												*25,600	*25,600	(18.5)

8.20 m (26' 11") boom, 6.30 m (20' 8") arm equipped with 800 mm triple grouser shoe.

Lift-point height m (ft)	Lift-point radius																At max. Reach										
	1.5 m (4.9 ft)		3.0 m (9.8 ft)		4.5 m (14.8 ft)		6.0 m (19.7 ft)		7.5 m (24.6 ft)		9.0 m (29.5 ft)		10.5 m (34.4 ft)		12.0 m (39.4 ft)		13.5 m (44.3 ft)		Capacity	Reach							
																							m (ft)				
10.5 m (34.4 ft)	kg																							*1,180	*1,180	10.88	
	lb																								*2,600	*2,600	(35.7)
9.0 m (29.5 ft)	kg																								*820	*820	11.94
	lb																								*1,810	*1,810	(39.2)
7.5 m (24.6 ft)	kg																								*1,870	*1,870	12.74
	lb																								*4,120	*4,120	(41.8)
6.0 m (19.7 ft)	kg																								*1,990	*1,990	13.31
	lb																								*4,390	*4,390	(43.7)
4.5 m (14.8 ft)	kg																								*2,290	*2,290	13.70
	lb																								*5,050	*5,050	(45.0)
3.0 m (9.8 ft)	kg																								*2,980	*2,980	13.92
	lb																										

LIFTING CAPACITY

Rating over-front Rating over-side or 360 degrees

HX220AL 2-PIECE BOOM

3.673 m boom 2-Piece, 292 m (6' 7") arm equipped with 600 mm (24") triple grouser shoe.

Lift-point height m (ft)	Lift-point radius								At max. Reach		
	3.0 m (9.8 ft)		4.5 m (14.8 ft)		6.0 m (19.7 ft)		7.5 m (24.6 ft)		Capacity	Reach	
											m (ft)
9.0 m (29.5 ft)	kg								*4,550	*4,550	4.46
	lb								*10,030	*10,030	(14.6)
7.5 m (24.6 ft)	kg		*6,200	*6,200	*5,300	*5,300			*3,630	*3,630	6.32
	lb		*13,670	*13,670	*11,680	*11,680			*8,000	*8,000	(20.7)
6.0 m (19.7 ft)	kg		*6,430	*6,430	*5,760	5,560			*3,300	*3,300	7.43
	lb		*14,180	*14,180	*12,700	12,260			*7,280	*7,280	(24.4)
4.5 m (14.8 ft)	kg	*10,530	*8,050	*8,050	*6,090	5,370	*4,920	3,730	*3,180	*3,180	8.11
	lb	*23,210	*17,750	*17,750	*13,430	11,840	*10,850	8,220	*7,010	*7,010	(26.6)
3.0 m (9.8 ft)	kg		*10,100	7,820	*6,730	5,080	*5,130	3,610	*3,200	2,950	8.47
	lb		*22,270	17,240	*14,840	11,200	*11,310	7,960	*7,050	6,500	(27.8)
1.5 m (4.9 ft)	kg		*11,830	7,210	*7,620	4,800	*5,440	3,470	*3,350	2,840	8.55
	lb		*26,080	15,900	*16,800	10,580	*11,990	7,650	*7,390	6,260	(28.1)
Ground Line	kg		11,830	6,880	7,480	4,590	5,370	3,370	*3,640	2,890	8.36
	lb		26,080	15,170	16,490	10,120	11,840	7,430	*8,020	6,370	(27.4)
-1.5 m (-4.9 ft)	kg	*11,710	*10,960	6,790	7,380	4,510	5,340	3,340	*4,180	3,140	7.88
	lb	*25,820	*24,160	14,970	16,270	9,940	11,770	7,360	*9,220	6,920	(25.9)
-3.0 m (-9.8 ft)	kg	*11,250	*8,920	6,870	*6,680	4,560			*4,770	3,710	7.05
	lb	*24,800	*19,670	15,150	*14,730	10,050			*10,520	8,180	(23.1)

- Lifting capacity is based on ISO 10567.
- Lifting capacity of HX A Series does not exceed 75% of tipping load with the machine on firm, level ground or 87% of full hydraulic capacity.
- The Lift-point is bucket pivot mounting pin on the arm (without bucket mass).
- (*) indicates load limited by hydraulic capacity.
- Caution: please be aware of the local regulations and instructions for lifting operations.

LIFTING CAPACITY

Rating over-front Rating over-side or 360 degrees



HX220AL HIGH WALKER

8.20 m (26' 11") boom, 6.30 m (20' 8") arm equipped with 800 mm triple grouser shoe.

Lift-point height m (ft)	Lift-point radius																At max. Reach					
	1.5 m (4.9 ft)		3.0 m (9.8 ft)		4.5 m (14.8 ft)		6.0 m (19.7 ft)		7.5 m (24.6 ft)		9.0 m (29.5 ft)		10.5 m (34.4 ft)		12.0 m (39.4 ft)		13.5 m (44.3 ft)		Capacity	Reach		
																					m (ft)	
10.5 m (34.4 ft)	kg																			*1,280	*1,280	11.04
	lb																			*2,820	*2,820	(36.2)
9.0 m (29.5 ft)	kg																					12.06
	lb																					(39.6)
7.5 m (24.6 ft)	kg																					12.82
	lb																					(42.1)
6.0 m (19.7 ft)	kg																					13.38
	lb																					(43.9)
4.5 m (14.8 ft)	kg																					13.74
	lb																					(45.1)
3.0 m (9.8 ft)	kg																					13.93
	lb																					(45.7)
1.5 m (4.9 ft)	kg																					13.96
	lb																					(45.8)
Ground Line	kg																					13.83
	lb																					(45.4)
-1.5 m (-4.9 ft)	kg	*2,110	*2,110	*3,080	*3,080	*5,620	*5,620	*5,890	3,670	4,510	3,670	*3,670	2,860	3,120	2,290	*2,730	1,870	*1,100	*1,100	*1,060	*1,060	13.52
	lb	*4,650	*4,650	*6,790	*6,790	*12,390	*12,390	*12,990	8,090	9,940	8,090	*8,090	6,310	6,880	5,050	*6,020	4,120	*2,430	*2,430	*2,340	*2,340	(44.4)
-3.0 m (-9.8 ft)	kg	*2,990	*2,990	*3,930	*3,930	*6,160	*6,160	*6,200	3,530	4,770	3,530	*3,870	2,760	*3,260	2,220	*2,820	1,830					13.03
	lb	*6,590	*6,590	*8,660	*8,660	*13,580	*13,580	*13,670	7,780	*10,520	7,780	*8,530	6,080	*7,190	4,890	*6,220	4,030					(42.8)
-4.5 m (-14.8 ft)	kg	*3,920	*3,920	*4,940	*4,940	*7,180	7,160	*6,290	3,470	4,890	3,470	*3,970	2,710	*3,320	2,190	*2,210	1,830					12.35
	lb	*8,640	*8,640	*10,890	*10,890	*15,830	15,790	*13,870	7,650	*10,780	7,650	*8,750	5,970	*7,320	4,830	*4,870	4,030					(40.5)
-6.0 m (-19.7 ft)	kg	*4,950	*4,950	*6,150	*6,150	*8,280	7,270	*6,160	3,490	4,830	3,490	*3,920	2,720	*3,230	2,220							11.42
	lb	*10,910	*10,910	*13,560	*13,560	*18,250	16,030	*13,580	7,690	*10,650	7,690	*8,640	6,000	*7,120	4,890							(37.5)
-7.5 m (-24.6 ft)	kg	*6,110	*6,110	*7,630	*7,630	7,480	*5,760	3,570	4,540	3,570	*3,640	2,800										10.19
	lb	*13,470	*13,470	*16,820	*16,820	16,490	*12,700	7,870	*10,010	7,870	*8,020	6,170										(33.4)
-9.0 m (-29.5 ft)	kg			*9,180	*9,180	*6,510	*6,510	*4,960	4,960	3,850	3,760											8.51
	lb			*20,240	*20,240	*14,350	*14,350	*10,930	10,930	8,490	8,290											(27.9)
-10.5 m (-34.4 ft)	kg																					
	lb																					











- Lifting capacity is based on ISO 10567.
- Lifting capacity of HX A Series does not exceed 75% of tipping load with the machine on firm, level ground or 87% of full hydraulic capacity.
- The Lift-point is bucket pivot mounting pin on the arm (without bucket mass).
- (*) indicates load limited by hydraulic capacity.
- Caution: please be aware of the local regulations and instructions for lifting operations.

LIFTING CAPACITY











 Rating over-front  Rating over-side or 360 degrees

HX220AL HIGH WALKER

5.68 m (18' 8") Mono boom, 2.00 m (6' 7") arm equipped with 600 mm (24") triple grouser shoe.



Lift-point height m (ft)	Lift-point radius								At max. Reach		
	3.0 m (9.8 ft)		4.5 m (14.8 ft)		6.0 m (19.7 ft)		7.5 m (24.6 ft)		Capacity	Reach	
											m (ft)
7.5 m (24.6 ft)	kg lb								*5,670 *12,500	*5,670 *12,500	5.23 (17.1)
6.0 m (19.7 ft)	kg lb			*5,470 *12,060	*5,470 *12,060				*5,530 *12,190	5,060 11,160	6.48 (21.3)
4.5 m (14.8 ft)	kg lb		*7,120 *15,700	*7,120 *15,700	*5,900 *13,010	5,600 12,350			*5,580 *12,300	4,220 9,300	7.21 (23.7)
3.0 m (9.8 ft)	kg lb		*8,930 *19,690	8,030 17,700	*6,650 *14,660	5,370 11,840	*5,740 *12,650	3,900 8,600	*5,720 *12,610	3,840 8,470	7.58 (24.9)
1.5 m (4.9 ft)	kg lb				*7,340 *16,180	5,170 11,400	5,910 13,030	3,820 8,420	5,760 12,700	3,730 8,220	7.63 (25.0)
Ground Line	kg lb		*10,520 *23,190	7,550 16,640	*7,710 *17,000	5,070 11,180			6,010 13,250	3,870 8,530	7.37 (24.2)
-1.5 m (-4.9 ft)	kg lb	*12,400 *27,340	*12,400 *27,340	*10,130 *22,330	7,580 16,710	*7,550 *16,640	5,070 11,180		*6,470 *14,260	4,340 9,570	6.78 (22.2)
-3.0 m (-9.8 ft)	kg lb	*12,040 *26,540	*12,040 *26,540	*8,890 *19,600	7,730 17,040				*6,690 *14,750	5,540 12,210	5.73 (18.8)
-4.5 m (-14.8 ft)	kg lb										

5.68 m (18' 8") Mono boom, 2.40 m (7' 10") arm equipped with 600 mm (24") triple grouser shoe.

Lift-point height m (ft)	Lift-point radius								At max. Reach		
	3.0 m (9.8 ft)		4.5 m (14.8 ft)		6.0 m (19.7 ft)		7.5 m (24.6 ft)		Capacity	Reach	
											m (ft)
7.5 m (24.6 ft)	kg lb								*4,990 *11,000	*4,990 *11,000	5.79 (19.0)
6.0 m (19.7 ft)	kg lb			*5,040 *11,110	*5,040 *11,110				*4,580 *10,100	4,560 10,050	6.94 (22.8)
4.5 m (14.8 ft)	kg lb		*6,570 *14,480	*6,570 *14,480	*5,540 *12,210	*5,540 *12,210	*5,190 *11,440	3,980 8,770	*4,490 *9,900	3,870 8,530	7.62 (25.0)
3.0 m (9.8 ft)	kg lb		*8,390 *18,500	8,120 17,900	*6,350 *14,000	5,390 11,880	*5,470 *12,060	3,900 8,600	*4,600 *10,140	3,550 7,830	7.97 (26.1)
1.5 m (4.9 ft)	kg lb		*9,850 *21,720	7,690 16,950	*7,120 *15,700	5,170 11,400	*5,830 *12,850	3,800 8,380	*4,920 *10,850	3,450 7,610	8.02 (26.3)
Ground Line	kg lb		*10,440 *23,020	7,510 16,560	*7,600 *16,760	5,040 11,110	5,820 12,830	3,730 8,220	*5,520 *12,170	3,560 7,850	7.78 (25.5)
-1.5 m (-4.9 ft)	kg lb	*11,820 *26,060	*11,820 *26,060	*10,270 *22,640	7,500 16,530	*7,600 *16,760	5,010 11,050		*6,070 *13,380	3,940 8,690	7.22 (23.7)
-3.0 m (-9.8 ft)	kg lb	*12,960 *28,570	*12,960 *28,570	*9,300 *20,500	7,620 16,800	*6,760 *14,900	5,110 11,270		*6,330 *13,960	4,860 10,710	6.25 (20.5)
-4.5 m (-14.8 ft)	kg lb										













- Lifting capacity is based on ISO 10567.
- Lifting capacity of HX A Series does not exceed 75% of tipping load with the machine on firm, level ground or 87% of full hydraulic capacity.
- The Lift-point is bucket pivot mounting pin on the arm (without bucket mass).
- (*) indicates load limited by hydraulic capacity.
- Caution: please be aware of the local regulations and instructions for lifting operations.

LIFTING CAPACITY















 Rating over-front  Rating over-side or 360 degrees

HX220AL HIGH WALKER

5.68 m (18' 8") Mono boom, 2.92 m (9' 7") arm equipped with 600 mm (24") triple grouser shoe.

Lift-point height m (ft)	Lift-point radius										At max. Reach								
	1.5 m (4.9 ft)		3.0 m (9.8 ft)		4.5 m (14.8 ft)		6.0 m (19.7 ft)		7.5 m (24.6 ft)		Capacity	Reach							
													m (ft)						
7.5 m (24.6 ft)	kg lb										*4,490 *9,900	*4,490 *9,900			*3,320 *7,320	*3,320 *7,320	6.44 (21.1)		
6.0 m (19.7 ft)	kg lb										*4,500 *9,920	*4,500 *9,920			*3,080 *6,790	*3,080 *6,790	7.49 (24.6)		
4.5 m (14.8 ft)	kg lb										*5,070 *11,180	*5,070 *11,180	*4,750 *10,470	4,010 8,840	*3,020 *6,660	*3,020 *6,660	8.13 (26.7)		
3.0 m (9.8 ft)	kg lb										*7,670 *16,910	*7,670 *16,910	*5,920 *13,050	5,420 11,950	*5,130 *11,310	3,900 8,600	*3,090 *6,810	*3,090 *6,810	8.46 (27.7)
1.5 m (4.9 ft)	kg lb										*9,330 *20,570	7,740 17,060	*6,780 *14,950	5,170 11,400	*5,570 *12,280	3,770 8,310	*3,290 *7,250	3,140 6,920	8.50 (27.9)
Ground Line	kg lb			*6,460 *14,240	*6,460 *14,240	*10,210 *22,510	7,480 16,490	*7,390 *16,290	5,000 11,020	5,770 12,720	3,680 8,110					*3,650 *8,050	3,220 7,100	8.28 (27.2)	
-1.5 m (-4.9 ft)	kg lb	*7,100 *15,650	*7,100 *15,650	*11,080 *24,430	*11,080 *24,430	*10,330 *22,770	7,410 16,340	*7,580 *16,710	4,930 10,870	5,750 12,680	3,660 8,070				*4,320 *9,520	3,510 7,740	7.75 (25.4)		
-3.0 m (-9.8 ft)	kg lb	*11,800 *26,010	*11,800 *26,010	*13,920 *30,690	*13,920 *30,690	*9,690 *21,360	7,480 16,490	*7,130 *15,720	4,980 10,980						*5,670 *12,500	4,190 9,240	6.86 (22.5)		
-4.5 m (-14.8 ft)	kg lb			*11,110 *24,490	*11,110 *24,490	*7,820 *17,240	7,730 17,040								*6,090 *13,430	5,970 13,160	5.42 (17.8)		

5.68 m (18' 8") Mono boom, 3.90 m (12' 9") arm equipped with and 600 mm (24") triple grouser shoe.

Lift-point height m (ft)	Lift-point radius										At max. Reach							
	1.5 m (4.9 ft)		3.0 m (9.8 ft)		4.5 m (14.8 ft)		6.0 m (19.7 ft)		7.5 m (24.6 ft)		9.0 m (29.5 ft)		Capacity	Reach				
															m (ft)			
7.5 m (24.6 ft)	kg lb										*2,760 *6,080	*2,760 *6,080			*2,300 *5,070	*2,300 *5,070	7.64 (25.1)	
6.0 m (19.7 ft)	kg lb										*3,690 *8,140	*3,690 *8,140			*2,160 *4,760	*2,160 *4,760	8.54 (28.0)	
4.5 m (14.8 ft)	kg lb										*4,100 *9,040	*4,100 *9,040	*3,970 *8,750	*3,970 *8,750	*2,560 *5,640	*2,560 *5,640	9.11 (29.9)	
3.0 m (9.8 ft)	kg lb			*9,120 *20,110	*9,120 *20,110	*6,160 *13,580	*6,160 *13,580	*5,010 *11,050	*5,010 *11,050	*4,440 *9,790	3,890 8,580	*3,630 *8,000	2,900 6,390	*2,150 *4,740	*2,150 *4,740	9.40 (30.8)		
1.5 m (4.9 ft)	kg lb			*7,910 *17,440	*7,910 *17,440	*8,080 *17,810	7,850 17,310	*6,000 *13,230	5,170 11,400	*4,990 *11,000	3,730 8,220	*4,110 *9,060	2,820 6,220	*2,270 *5,000	*2,270 *5,000	9.44 (31.0)		
Ground Line	kg lb			*7,390 *16,290	*7,390 *16,290	*9,450 *20,830	7,410 16,340	*6,820 *15,040	4,920 10,850	*5,470 *12,060	3,590 7,910	*3,760 *8,290	2,750 6,060	*2,480 *5,470	*2,480 *5,470	9.23 (30.3)		
-1.5 m (-4.9 ft)	kg lb	*5,820 *12,830	*5,820 *12,830	*9,770 *21,540	*9,770 *21,540	*10,070 *22,200	7,210 15,900	*7,300 *16,090	4,780 10,540	5,590 12,320	3,510 7,740				*2,840 *6,260	2,840 6,260	8.77 (28.8)	
-3.0 m (-9.8 ft)	kg lb	*8,970 *19,780	*8,970 *19,780	*13,670 *30,140	*13,670 *30,140	*9,970 *21,980	7,190 15,850	*7,310 *16,120	4,750 10,470	5,600 12,350	3,510 7,740				*3,500 *7,720	3,240 7,140	7.99 (26.2)	
-4.5 m (-14.8 ft)	kg lb	*13,000 *28,660	*13,000 *28,660	*13,200 *29,100	*13,200 *29,100	*9,020 *19,890	7,330 16,160	*6,540 *14,420	4,860 10,710						*4,940 *10,890	4,130 9,110	6.80 (22.3)	
-6.0 m (-19.7 ft)	kg lb					*6,270 *13,820	*6,270 *13,820											

- Lifting capacity is based on ISO 10567.
- Lifting capacity of HX A Series does not exceed 75% of tipping load with the machine on firm, level ground or 87% of full hydraulic capacity.
- The Lift-point is bucket pivot mounting pin on the arm (without bucket mass).
- (*) indicates load limited by hydraulic capacity.
- Caution: please be aware of the local regulations and instructions for lifting operations.

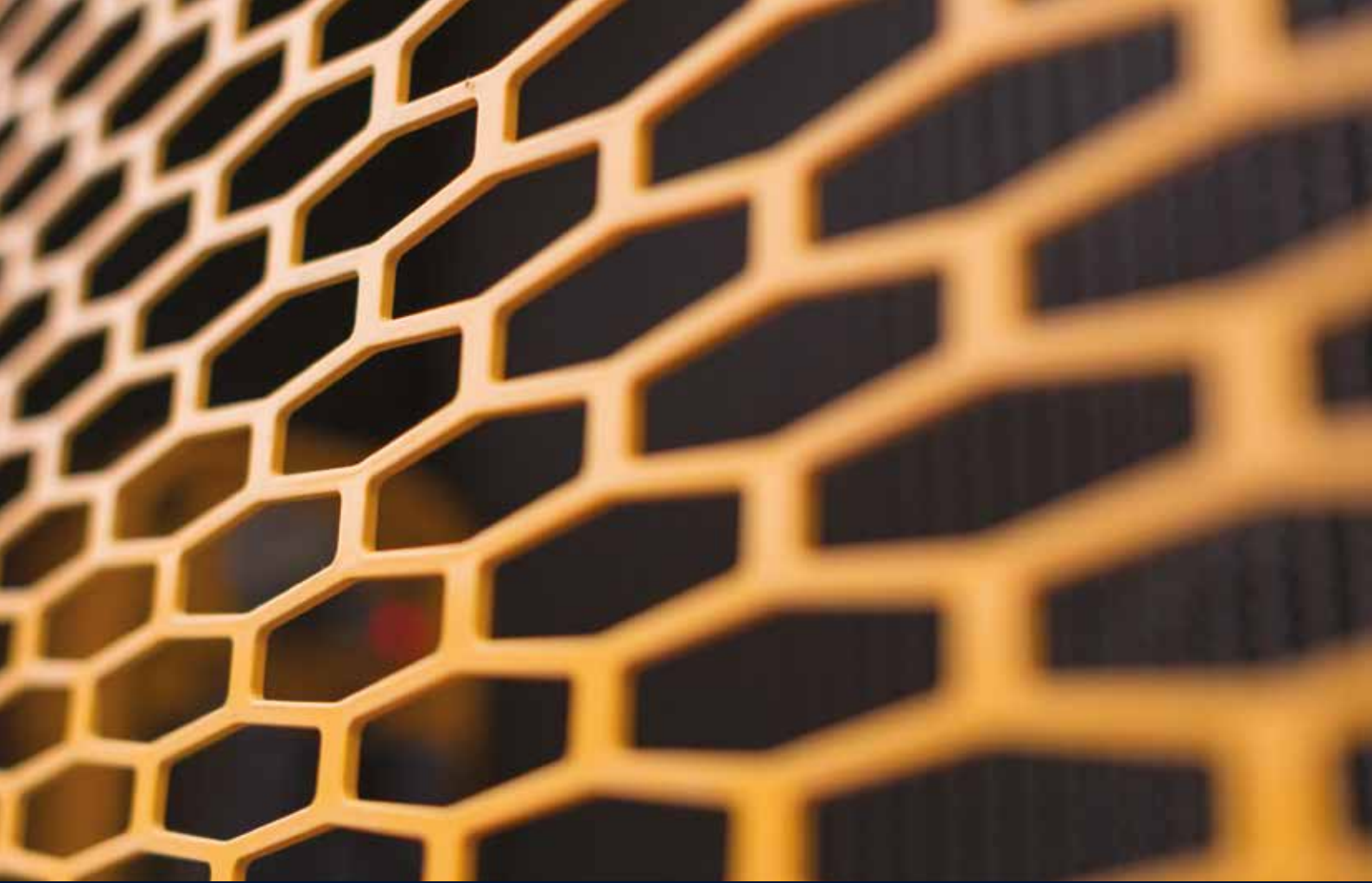

Specifications and design are subject to change without notice. Pictures of Hyundai Construction Equipment Europe products may show other than standard equipment.

Hyundai Construction Equipment Europe nv.
Hyundailaan 4, 3980 Tessenderlo, Belgium.
Tel: (32) 14-56-2200 Fax: (32) 14-59-3405

EN-2021.01 Rev 2

Ready to experience the Hyundai Effect?

Contact your Hyundai dealer.

hyundai-ce.eu/en/dealer-locator

